



Fiery JobMaster-Fiery Impose-Fiery
Compose

© 2014 Electronics For Imaging. The information in this publication is covered under Legal Notices for this product.

26 June 2014

Contents

Fiery JobMaster-Fiery Impose-Fiery Compose	7
Fiery JobMaster	8
Activate the Fiery JobMaster license	8
Open a job in Fiery JobMaster	8
Add a new job	9
Import and edit a scan in Fiery JobMaster	9
Edit a page in Fiery JobMaster	10
Add page numbers in Fiery JobMaster	11
Insert and edit tabs in Fiery JobMaster	12
Add multiple tab styles to a document	12
Bleed edge tabs in Fiery JobMaster	14
Add content to bleed edge tabs	15
Specify position of bleed edge tabs	15
Fiery Impose	17
APPE processing in Fiery Impose and Fiery Compose or Fiery JobMaster	17
Access Fiery Impose	18
Make a job spooled/held	18
Access Fiery Impose from Command WorkStation	18
Access Fiery Impose from Job Properties	18
Imposition layouts	19
Adding blank pages to adjust layout	19
Gangup printing in Fiery Impose	19
Gang Up imposition methods for VDP jobs	21
Set Fiery Impose preferences	23
Set imposition scale and finish size	23
Set paths to imposition files	24
Set PostScript conversion for imposition	24
Set imposition measurement units	24
Set the application language	25
Preview a job for imposition	25
View and measure sheet dimensions	25
View sheets of imposed jobs	25

Imposing a job	26
Imposition templates	26
Apply an Imposition template	27
Save a custom Imposition template	27
Delete a custom template	27
Save an imposed job	27
Imposition template reference	28
Choose a product intent workflow	38
Imposition settings	39
Finish size options for Fiery Impose	39
Set sheet size in Fiery Impose	39
Set Duplex in Fiery Impose	40
Scale settings in Fiery Impose	40
Specify Scale settings	40
Set cover media	41
Set the layout orientation	41
Bleeds for workflows in Fiery Impose	41
Set bleeds	41
Set printer's marks in Fiery Impose	42
Define printer's marks	42
Set Trim marks	42
Set Fold marks	43
Set job label attributes	43
Set blank page text	43
Set registration marks and barcode in Fiery Impose	44
Specify booklet settings in Fiery Impose	46
Specify binding settings for Booklet	46
Specify row & column settings for Booklet	46
Specify Row & Column settings for Gangup	46
Specify Creep settings	47
Specify Gangup settings in Fiery Impose	48
Set Gangup style	48
Set Page Order	48
Set Gutters	48

Scale to fit options with gutters	49
Set Gang Up methods in Fiery Impose	49
Combining Gangup styles with Gangup methods	49
Specify Repeat Booklet finish feature	50
Styles available for edge-binding options	50
Modify pages manually in Fiery Impose	52
Rotate pages	52
Edit page content	52
Edit page content with PitStop	52
Reorder pages	52
Insert blank pages manually	53
Delete pages	53
VDP in Fiery Impose	54
Open or preview a VDP job	54
Imposing a VDP job	54
Print control strips for VDP jobs	55
Specify booklet, scale, or bleeds for VDP imposition	55
Set multi-up booklet for VDP jobs	55
Set bleeds or scaling in VDP imposition	56
Gang Up settings for VDP imposition	56
Single Record Imposition for VDP jobs	57
Multiple Records Imposition for VDP jobs	57
Duplo VDP Gang Up	58
Fiery Compose	59
Setting job options before using Fiery Compose	59
Open and view jobs in Fiery Compose	59
Open a job in Fiery Compose	60
Set the Sheet View to thumbnails or full pages in Fiery Compose	60
View pages as a book	61
Adjust thumbnail size	61
Work with pages in Fiery Compose	62
Open a job for editing in Acrobat	62
Reorder, delete, or set duplex for pages in Fiery Compose	62
Insert pages from another job in Fiery Compose	62
Insert a blank sheet or page in Fiery Compose	62

Assign media to pages in Fiery Compose	63
Work with chapter starts in Fiery Compose	63
Set tabs in Fiery Compose	63
Set tab text and other properties in Fiery Compose	64
Set up covers	64
Subset finishing in Fiery Compose	65
Specify a set definition in Fiery Compose	65
Apply subset finishing in Fiery Compose	66
Specify subset finishing for Z-fold in Fiery Compose	67
Manage jobs in Fiery Compose	67
Save a job in Fiery Compose	67
Delete a job that is open in Fiery Compose	67
Fiery Preview	68
View information for processed jobs	68
View spooled, unprocessed jobs	69
Page View, Sheet View, and Reader View	70
Settings pane	72
Open Reader View	73
Toolbar icons in Preview	74
Preview a raster image	75
Toolbar icons in Raster Preview	75
Merging pages in Raster Preview	76
VDP Raster Preview	76
Index	79

Fiery JobMaster-Fiery Impose-Fiery Compose

Fiery make-ready software integrates labor-intensive document preparation activities at both the sheet level and page level in one visual interface.

These integrated job preparation tools offer the following modes, depending on what client license is available:

- Fiery JobMaster provides advanced PDF-based job preparation tools for scanning, tab creation and insertion, page numbering, chapter creation, and late stage editing. It includes all functions of Fiery Compose.
- Fiery Impose applies imposition layouts to jobs for custom printing, binding, and trimming. Fiery Impose also applies impositions to variable data jobs and saves imposed jobs as PDF files.
- Fiery Compose allows you to define the chapter divisions of a job, print ranges of pages on varying types of media, insert blank media between pages, and insert tab media containing text labels (if the printer supports tab printing).
- Preview provides a preview of a job before it is processed and is a standard feature of Command WorkStation. Users can do a soft proof of each sheet surface of a job before it is processed. The visual interface changes dynamically to display any changes made in preparing documents for printing.

The Fiery make-ready applications are supported on both Windows and Mac OS computers. For information about system requirements, see *Configuration and Setup* for your Fiery Server.

Fiery JobMaster

Fiery JobMaster is an advanced PDF-based job-preparation solution designed to help operators deal with complex document tasks such as tab insertion, scanning, chapterization, page numbering, and late stage editing. Fiery JobMaster, along with Fiery Impose and Fiery Compose, is one of the Fiery make-ready applications.

Note: To use Fiery JobMaster (or Fiery Impose or Fiery Compose), you must have a license activated on your client computer. You need a License Activation Code (LAC); if you do not have one, contact your Fiery dealer or printer manufacturer.

Fiery JobMaster includes Fiery Compose options, although Fiery Compose is also available as a separate licensed option.

Fiery JobMaster is accessed from Command WorkStation and opens in the Fiery JobMaster window.

Adobe Acrobat and Enfocus PitStop Pro are provided in the the Fiery JobMaster kit. Adobe Acrobat and PitStop allow editing in Acrobat from Fiery JobMaster, and can be used in some cases to convert PostScript files to PDF for Fiery JobMaster. For more information about installing Acrobat and PitStop, see *Utilities*, which is part of the user documentation set.

For important information about this release of Fiery JobMaster, see the release notes at <http://help.efi.com/fea>.

Activate the Fiery JobMaster license

To activate the Fiery JobMaster license, you must have a License Activation Code (LAC). You can activate the license automatically if your computer is connected to the Internet, or manually if your computer is not connected to the Internet.

- 1 In Command WorkStation, right-click a job and choose JobMaster, or Preview if JobMaster is not displayed.
 - If you chose JobMaster, and you are asked whether to activate the option, click Yes.
 - If you chose Preview, select Help > Manage License in the Fiery Preview window.
- 2 In the License Activation window, click the Help icon and follow the instructions.

Open a job in Fiery JobMaster

When you have activated your license, you can start to use Fiery JobMaster. Open a PostScript or Adobe PDF file from Command WorkStation. The job must be in a spooled/held state.

If you select a processed/held job, and choose Actions > Preview, the job opens in the Raster Preview window. To edit a processed job in Fiery JobMaster, you must first remove the raster from the job. Select the job in the Held list and choose Actions > Remove Raster.

- 1 Select a spooled/held job in the Held list of Command WorkStation.
- 2 Choose Actions > JobMaster.
- 3 Option-click (Mac OS) or Alt-click (Windows) a page in the Sheet View pane to select the same page in the Page View pane.

You can now acquire scans, edit them, and place them in your job; edit pages and add page numbering; and insert tabs and edit the tabs and the tab text.

Add a new job

You can create a blank new job in Fiery JobMaster (or Fiery Impose/Fiery Compose).

Before you begin

You must have Fiery JobMaster (or Fiery Impose/Fiery Compose) licensed on your computer to create a new job. You cannot create a new job in Fiery Impose demo version.

You can create a job entirely in Fiery JobMaster, including tab and scan jobs. This is useful when you do not have any digital content already stored on the Fiery Server.

- 1 Click the New Job icon in the Command WorkStation tool bar.
If the New Job icon is not visible in the tool bar, add it using the Customize feature in Command WorkStation. See *Command WorkStation Help* for more information.
Your new job opens in Fiery JobMaster with a single blank page, with the default page size set in Command WorkStation Preferences.
- 2 Apply settings as required.
- 3 Insert pages from an existing job, if required.
You can only insert pages from the source PDF document. You cannot insert pages that were previously added as inserted tabs to that job.

Import and edit a scan in Fiery JobMaster

You can import a scan using Fiery Remote Scan TWAIN plug-in when it is installed on your computer. You can then adjust aspects of the scan, such as size, brightness, and despeckling.

You can use the functions in the Scan Preview & Edit window only during the scan operation. You cannot apply these functions to pages that are already part of a Fiery JobMaster-Fiery Impose job.





- 1 Right-click a held job in Command WorkStation Job Center, and select JobMaster.
- 2 In the Fiery JobMaster window, select Actions > Insert Pages or Insert > Insert Pages.
- 3 In the Insert Pages window, select Scan.
- 4 If not selected, choose Fiery Remote Scan 6 from the list of scanners and click Scan.
You can select a different scanner if its TWAIN plug-in is installed on your computer.

5 Select the Fiery Server to connect to.

For instructions on how to use Fiery Remote Scan, click the Help icon in the Fiery Remote Scan window.

6 Select From MailBox or Scan, and follow the instructions in *Fiery Remote Scan Help*.

7 To edit the scan, use the options in the Scan Preview & Edit window. These options are available on a per page basis, or if the Apply to All button is selected, to all pages in the scan job.

- Acquire  - Acquires the scan from either the mailbox or the printer.
- Select , Move  - Selects or moves the scanned image in the viewer.
- Zoom  - Zooms in and out. Click the icon to fit the scanned page to the preview window.
- Deskew - Straightens an image.
- Despeckle - Removes tiny dots or specks that sometimes appear on scanned images.
- Media Size - Automatically applies the nearest page size from the page size list to the scanned page, rotated as necessary. For example, 8.48 x 10.98in would result in 8.5 x 11in portrait and if the image is rotated, 8.5 x 11in landscape.

Note: Scan Size sets the final page size to the original scan size. Page Size defines the imported document page size. The scanned image will be resized to that page size. The page sizes listed are determined by the printer driver.

- Width, Height - Determined by the selections in Media Size and Orientation.
- Delete this page  - Deletes the selected page in the preview window.

Note: Additional pages can also be scanned and added to the existing scan job.

8 Click Import.

9 In the Insert Pages window, select scanned pages and drag them onto the Page View pane in the Fiery JobMaster window.



Edit a page in Fiery JobMaster

With Fiery JobMaster, you can edit pages of a job by rotating, masking, and cropping. You can also change the trim size or crop box size.

1 Right-click a spooled/held job in Command WorkStation, and choose JobMaster.

2 In the Page View pane, select the page or pages you want to edit and choose Actions > Edit page.

3 Specify the settings. Click OK when you finish.



- Panning  - Moves the scanned image in the preview window.
- Mask  - Masks one or more areas of the page. Click and then draw the area to be masked. Applies the same masked areas to all of the selected pages before opening the Edit Page window. Overrides masks previously made on any of these pages.

- Zoom  - Zooms in and out. (Click the icon to fit the scanned page to the preview window.)
- Mode - Margin lets you adjust the existing crop box or trim box. By applying a margin, you can define how much smaller (or larger) the new crop/trim box will be than the original one. Offset lets you (with the Size option) define an entirely new size for the crop/trim box, and can position the new crop/trim size directly against the existing content. It also enables the Predefined Crop Size menu for Crop Box.
- Crop Box, Trim Box - To enable, click the Disabled button. See Mode.

Add page numbers in Fiery JobMaster

In Fiery JobMaster, you can add page numbers and content to different pages of your job and specify a number of parameters.

- 1 Right-click a spooled/held job in Command WorkStation, and choose JobMaster.
- 2 In the Page View pane, select a page or pages, and choose Actions > Edit numbering.
- 3 In the Page Numbers & Stamping window, specify the settings. You can preview choices you make in the Fiery JobMaster window. When you finish, click OK.

- Select  , Move  - Selects or moves the image.
- Page Numbers - To enable, click the Disabled button. Displays page number options, as well as the Background button and its options.
- Text - Use the plus sign to access menus for specifying page numbers, date, time, and the name of the document. The default position of this text is the lower right corner of the page. You can change the size of the field in the Preview window. You can also move it to other locations by using the Select tool.
- Background - To enable, click the Disabled button. Select color and opacity of background in the page number field.
- Start at - Enter the page number you want used for the first page of the job. Page numbering always counts from the first page of the job. For example, if the start page is listed as "6", then the page number of the first page will be "6", the second page will be "7", and so on.
- Increment - Specify the increment between the page numbers. You can specify the page count to increase page by page or every second page.
- Format - Specify the page numbering format. Choices include: A,B,C; a,b,c; I,II,III; i,ii,iii.
- Print on - Specify whether to print the page numbering information on both pages, front only, or back only.
- Mirror - Positions page numbers in mirror image on facing pages.
- Count Tabs & Inserts - Includes inserted tabs or blank pages when calculating the page numbers.
- Print on tabs - Prints the page numbers on the inserted tabs.
- Force front side to odd page number - Select the check box to make sure the front side of the sheet is always an odd-numbered page. The front side of the sheet is typically the right-hand page of a reader's view. This is useful for chapter starts in booklets.
- Zoom  - Zooms in and out. Click the icon to fit the scanned page to the preview window.

Insert and edit tabs in Fiery JobMaster

If tab printing is supported by the Fiery Server, you can insert tabs and specify text and media settings for them. In the Tab Media window you can save media settings as a preset. You can define custom tabs and those settings are included in the preset.

You can specify two tab styles in a single document. This allows you to identify chapters and sub-chapters in long documents. See [Add multiple tab styles to a document](#) on page 13.

The Tab Media window displays an image of the tab ear with measurements. When you change the number of tabs in a set, the measurements shown in the displayed tab change. You can specify up to 50 tabs in a set.

To convert a normal page to a tabbed page, select the page's Convert to tab option.

Note: The Convert to tab option in earlier versions of Fiery Compose has been removed. To convert an existing page in the document, or an inserted page, to a tab in Fiery Compose, right-click and select **Assign Media**, then select a tab media from the list.

- 1 Right-click a spooled held job in Command WorkStation, and choose JobMaster.
- 2 To insert a tab, select a page or pages in the Page View pane, and click **Actions > Insert tab**.
- 3 To edit a tab, right-click it in the Page View or Sheet View pane, and click **Edit Tab**.
- 4 Specify settings in the Edit Tab window.
 - **Text** - If you have more than one tab in your document, select the tab to specify settings for it. When you add text to a tab, you can select the next or previous tab by pressing **Ctrl+Right Arrow** (Windows) or **Cmd+Right Arrow** (Mac OS).
 - **Background Color** - Click the Disabled button to enable.
 - **Background Image** - A background image can be a BMP, JPEG (JPG), PNG, TIFF (TIF), or GIF file. When you select a background image to place on the tab, you can specify opacity, scale, and rotation, and set margins relative to the tab size.
- 5 To specify media settings, click the Edit button beside the Media Preset field, and specify settings:
 - **Tab sequence** - Indicates the order in which the tabs are printed.
 - **Output tray to kick out unused tabs** - Use this setting if you are printing a job that does not use all the tabs in the set. For instance, if you are using only three tabs of a five-tab set, the two unused tabs will be output to the tray you select.
 - **Tab shift (Convert to Tab)** - Use for tabs that have been converted from an existing page.
- 6 (Optional) To save the media settings as a preset, click the Save Preset icon next to the Media Preset menu and name the Preset.

Presets are displayed in the Tab Media window and the Edit Tab window.

- 7 Click OK in the Tab Media window.
- 8 Click OK in the Edit Tab window.

Add multiple tab styles to a document

You can add multiple tab styles to a document in Fiery JobMaster, if your printer supports the feature. You can nest the different tab styles also, if your printer supports the feature.

Before you begin

Import the spooled job into Fiery JobMaster.

You can create multiple tab styles and then either insert tabs or convert existing pages to tabs in a single job, and assign the tab styles.

1 Do one of the following in the Page View pane:

- To convert an existing page in your document, right-click and select **Convert to Tab**.
- To insert a new tab, right-click a page and select **Insert Tab**. The tab is inserted as the page before.

If your printer supports multiple tab styles, the available tab styles are listed. You can also create a new tab style by clicking **Create New** if the option is available.

2 Select a tab style for your selected tab style.

3 Continue to add tabs and select one of the available styles. In addition, you can do the following:

- To change the tab media, right-click a tab page, and select **Change Tab Media**.
- Right-click a tab page, and select **Edit Tab** to make changes to the tab style. See [Insert and edit tabs in Fiery JobMaster](#) on page 12.
- Choose to nest multiple tab sets by selecting **Nest multiple tab sets** in the **Edit Tab** window.

Note: If you choose not to select this option, each of the tab styles will be assigned sequentially wherever they are in the job. See the example below.

4 To view the information about the tab style selected for a specific page, click on the tab page.

The tab style information uses the following terminology:

- **Tab ear** - a single ear that sticks out from the edge of the media
- **Tab bank** - a single series of tab ears that often spans the media edge
- **Tab cut** - the position of the tab within a tab bank
- **Tab set** - multiple banks with the same tab styles that make up a tab set
- **Tab style** - media attributes of the tab set (number of ears, first tab offset, reading order)

When you choose to nest multiple tab styles in a single job, the tabs using the second tab style selected will be nested within the first tab style's bank of tabs. For instance, you assign Tab Bank 1 with 3 sets of tabs to the first two tabs in the job. You then assign Tab Bank 2 with 5 sets of tabs to the third and fourth tabs in the job. When you assign the fifth tab in the job to Tab Bank 1, the tab will be position number 3 in that bank. If you then assign the sixth tab in the job to Tab Bank 2, the tab will be position number 1 in that bank. If you move the first tab of Tab Bank 2 before the first tab of Tab Bank 1 in the job, then Tab Bank 2 becomes the primary style, and Tab Bank 1 is nested within Tab Bank 2. Unused tabs in a bank will use the Output tray to kick out unused tabs option in the Tab Media window.

If you choose not to nest multiple tab styles in a single job, then the tabs for each tab style will be assigned sequentially in the job. Then, using the Tab Bank 1 and Tab Bank 2 example above, the sixth tab in the job which has been assigned to Tab Bank 2 will be position number 3 in that tab bank.

Bleed edge tabs in Fiery JobMaster

Bleed edge tabs are printed on the page itself, not on tabs. The tabs bleed 1/8-inch beyond the defined edge of the page based on the trim box. You can position bleed edge tabs anywhere and specify different content for each set of tabs.

The bleed edge tabs are applied to pages in the document. When pages are added or removed before the pages with the bleed edge tabs, the page ranges in the bleed edge tabs List view are updated to reflect the new position of the original pages in the job. When pages are inserted between, or removed from, pages listed in a bleed edge tab page range, the page range changes to reflect the changed pages.



Bleed edge tabs *cannot* be added to the following types of pages in a job:

- Inserted sheets
- Inserted tabs
- Implicit blanks
- Pages converted to tabs

When adding bleed edge tabs to a job, first specify the content of the bleed edge tabs, and then the position of the tabs. You can preview the settings for both content and position.

Tools in Bleed Edge Tabs window

The Bleed Edge Tabs window provides several tools, including the following:

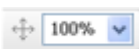
-  - Use to select the image.
-  - Use to move the image.
-  - Select a zoom percentage, or click the icon to fit the page to the preview window.

You can also page through the document by using the navigation arrows or entering a page number in the page text field.

Add content to bleed edge tabs

In Fiery JobMaster you can define sets of bleed edge tabs, add styled text, and add background color and images.

- 1 Select a job in the Command WorkStation Held list and choose Actions > JobMaster.
- 2 Select any page of the job in the Page View pane and choose Actions > Edit Bleed Edge Tab.
As you specify settings in the Bleed Edge Tabs window, you can preview your settings by clicking Preview.
- 3 In the Bleed Edge Tabs window, select the Content tab, and then select List.
- 4 Specify the ranges for the bleed edge tabs by entering the page numbers in the From and To fields. Press Enter to create a row for the next set.
Page ranges must be sequential and cannot overlap. You can skip some pages for chapter beginnings. To delete a page range, select the range and the minus button at the bottom of the window.
- 5 To specify text for all bleed edge tabs in a range, select a range and enter text in the Type text field. Specify text settings such as font and orientation.
- 6 To add a background fill, select a color and percentage opacity.
To enable the Background option, click the Disabled button.
- 7 To add an image to all tabs, click the Disabled button to enable the Image area, and browse to select an image.
The image can be in BMP, JPEG, TIFF, TIF, GIF, or PNG format. You can also specify settings such as opacity and set margins relative to the tab size.
- 8 Click the Apply styles to all button to specify which styles you want to apply to which sets of tabs.
By default, styles apply only to the tabs in the current section. Selecting Apply styles to tabs of the same position also applies the checked items to all tab sections that are in the same tab position.

Specify position of bleed edge tabs

In the Fiery JobMaster Bleed Edge Tabs window, you can specify the position of the bleed tabs in the final output. The position you specify applies to all the tabs in the job.

- 1 Select a job in the Command WorkStation Held list and choose Actions > JobMaster.
- 2 Select any page of the job in the Page View pane and choose Actions > Edit Bleed Edge Tab.
- 3 In the Bleed Edge Tabs window, select the Position tab.
- 4 Specify settings. To preview your settings, click Preview at any time.
 - Number of tabs - Specify up to 99 tabs.
 - Media size - Changes media size for output, and changes preview.

Note: The trimbox value specifies that the bleed edge tabs are placed along the trimbox by the side of the document, as defined in the original PDF file or in trimbox settings in the Edit Page feature.

- Printing area - Use Auto to base the tab ear's height and width on the media size, number of tabs, and distances between the tabs. Use Custom to specify a different height and width.
- Repeat Style - Changes the pattern of how tabs are placed on the pages.

Fiery Impose

Fiery Impose, which is one of the Fiery make-ready applications along with Fiery JobMaster and Fiery Compose, applies imposition layouts for special printing and binding needs. You can also impose variable data printing jobs when you use Fiery Impose.

Fiery Impose lets you:

- Specify how many rows and columns of pages to image on a sheet. You can use predefined layouts for common impositions or create custom layouts.
- Set the placement of pages on a sheet; the Fiery Impose layout designates the location of folds, cuts, and other elements with printer's marks.

Fiery Impose allows you to image multiple pages on a single sheet.

- Apply advanced job preparation tasks to your job in the same workflow using Fiery JobMaster, if enabled.
- Apply mixed media settings to your job in the same workflow as imposition settings, if you have enabled Fiery Compose.

Note: Fiery Compose features are included in Fiery JobMaster.

Fiery Impose requires Adobe Acrobat with Enfocus PitStop. We recommend you use the version of Acrobat provided in the kit.

You access Fiery Impose, Fiery JobMaster, and Fiery Compose from Command WorkStation, and open them in the Fiery Preview window.

For more information about installing Acrobat and PitStop, see *Utilities*, which is part of the user documentation set.

Fiery Impose license

Your workstation must have an activated Fiery Impose license to use the full functionality of Impose. Without an activated license, Fiery Impose runs in Demo mode, which:

- Applies a watermark to print jobs
- Lets you save imposed jobs in .dbp format to the Fiery Server
- Does not save imposed jobs in Adobe PDF format to a hard drive or Fiery Server

APPE processing in Fiery Impose and Fiery Compose or Fiery JobMaster

Fiery Impose and Fiery Compose, or Fiery JobMaster support APPE (Adobe PDF Print Engine), a PDF-based processor that allows direct processing of PDF jobs without conversion to PostScript.

You turn on APPE in Configure in Command WorkStation, but you can turn it off on a per-job basis in Job Properties.

If the following options are set, the job is processed through CPSI (Configurable PostScript Interpreter) rather than APPE:

- Tab jobs in the Normal product intent
- Sheet Size specified through Mixed media in Normal, Booklet, and Gangup product intents

Note: Sheet Size changed in Compose product intent is supported.

These restrictions apply for imposed jobs in Job Properties:

- N-up jobs with the Print border option
- 1-up Perfect binding jobs inside the Booklet layout option

Jobs using non-supported features are processed through the PostScript interpreter.

Access Fiery Impose

You can access Fiery Impose directly from Command WorkStation or from the Job Properties dialog box for a selected job.

Note: You can open a PostScript, Adobe PDF (Portable Document Format), or VDP file, but it must show a spooled/held status.

Make a job spooled/held

A job must be spooled/held to be opened in Fiery Impose.

- Do one of the following:
 - For a processed/held job, select the job in the Held list and click Actions > Remove Raster.
If you select a processed/held job, and choose Actions > Preview, the job opens in the Raster Preview window.
 - For a printed job, select the job in the Printed list and click Actions > Hold.

Access Fiery Impose from Command WorkStation

You can open a job in Fiery Impose directly from Command WorkStation.

- 1 Select a spooled/held job in the Held list of Command WorkStation.
- 2 Choose Actions > Impose.

Access Fiery Impose from Job Properties

When you open a job in the Fiery Impose window from Job Properties, the job appears in wireframe view in the Sheet View pane. Compose settings and product intent controls in the Settings pane are not available.

- 1 Do one of the following:
 - Click a spooled/held job in the Held list.
 - For a Hot Folder, click the Hot Folder in the Fiery Hot Folders Console.
- 2 Click Actions > Properties.
- 3 Click the Layout tab, and then click Impose.
- 4 Click Edit Impose Templates.

Imposition layouts

Fiery Impose provides predefined layouts for common impositions such as booklets and brochures. You can also create and save custom layouts.

Fiery Impose supports layouts of up to 100 pages per sheet, in a matrix of up to 10 rows by 10 columns (200 pages duplex). Gang Up printing methods support all layout of rows and columns. Binding methods (Saddle, Nested Saddle, Perfect) support only the 1 x 2, 2 x 1, and 2 x 2 layouts.

Duplex printing

Not all printers support duplex printing, and of those that do, implementations can vary. Fiery Impose supports duplex printing that corresponds to the print options of the printer.

Gutter sizes

Fiery Impose defines the locations of gutters for you according to the layout and sheet size governing the imposition of the job.

Setting margins

The size and location of the margin (the area between the outside edge of a group of imposed pages and the edge of the sheet) depends on the printer associated with the job. You cannot set custom margins.

Adding blank pages to adjust layout

Fiery Impose and Fiery Compose let you add blank pages, and also insert blank pages where necessary for the imposition layout you select.

A book layout must adjust the placement of pages according to the total number of pages in the job. If the total page count is not an even multiple of the number of pages in the layout, one signature may be laid out, typically with blank pages, to accommodate the discrepancy.

Depending on the Row and Column setting, as many as seven blank pages may be created. (For example, seven blank pages may be created for a 2X2 layout).

Gangup printing in Fiery Impose

Fiery Impose provides Gang Up Repeat, Gang Up Unique, and Unique-Collate Cut imposition.

Fiery Impose also offers Duplo Long Edge Feed and Duplo Short Edge Feed for imposition jobs being finished on a Duplo offline finisher with bindery features such as folding, slitting, cutting, and creasing.

Gang Up Repeat

The Repeat option enables "step-and-repeat" printing. Step-and-repeat is most often used when printing multiple copies of a single document.

Gang Up Unique

The Unique option places pages in an arrangement that is often more appropriate for printing a single copy of a job. This option does not fully collate itself (hand collating is necessary), but optimizes the sheet size while limiting the run to a single copy.

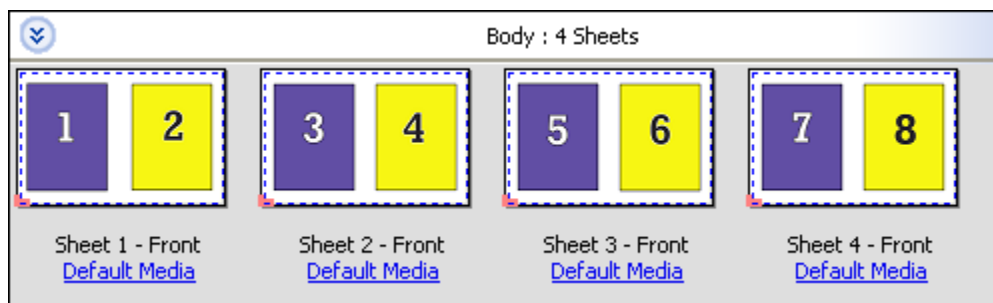

Unique-Collate Cut

Unique-Collate Cut places pages in an arrangement that allows the pages to fall into the correct order when the sheets are stacked and cut. This option minimizes the need for collating by hand and is most appropriate for printing single copies of a document.

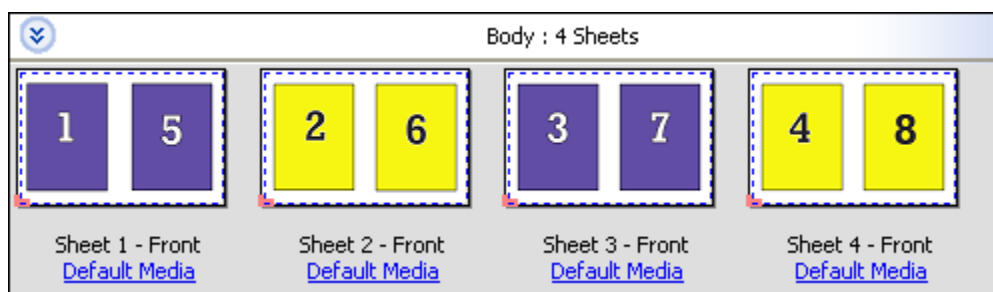

Duplo - Short Edge Feed

Duplo Short Edge Feed sets a pagination direction that enables feeding the final printed sheet into a Duplo finisher at the sheet's short edge. The columns or rows are perpendicular to the shortest sheet edge.

VDP and non-VDP PDF and PostScript jobs can use Duplo finishing. You can automatically configure Duplo offline finishers by reading a simple barcode printed on the sheets. The finisher reads a registration mark on the sheet and positions the sheet in relation to the mark as the sheet feeds through the machine. When specifying Duplo for a gangup imposition layout, you can specify the registration and barcode in the printer's marks dialog box.

Duplo - Long Edge Feed

Setting Duplo Long Edge Feed for a gangup imposition layout creates a pagination direction that enables the final printed sheet to be fed into a Duplo finisher at the sheet's long edge. The columns or rows are arranged in a direction perpendicular to the longest sheet edge.

You can use Duplo finishing for VDP and non-VDP PDF and PostScript jobs. Reading a simple barcode printed on the sheets automatically configures Duplo offline finishers. The finisher compensates for stack drift and image shift by reading a registration mark printed on the sheet and positioning the sheet in relation to the mark as the sheet feeds through the machine.

When specifying Duplo for a gangup imposition layout, you can specify the registration and barcode in the printer's marks dialog box.

Gang Up imposition methods for VDP jobs

For Variable Data Printing (VDP) jobs, you can use single-record or multiple-record imposition methods.

- Single-Record Imposition can use Gang-up repeat, Gang-up unique, or Unique collate cut. See [Gangup printing in Fiery Impose](#) on page 20.
- Multiple Record Imposition can use Multi-Record Collate, Cut and Stack, or Stack Size.

Multi-Record Collate

Multi-Record Collate places pages from different records sequentially on the sheet surface. The first page from each record is placed on the sheet surface until all the records are exhausted. Then a new sheet is started, and the second page from each record is placed until all the records are exhausted. The process is repeated until all the pages are placed.

The following preview shows a 2-by-2, simplex, Multi-Record Collate layout applied to a VDP job that contains four records. The records consist of four pages each. "R" stands for Record, and "P" for Page. For example, "R1 P1" is Page 1 for Record 1.

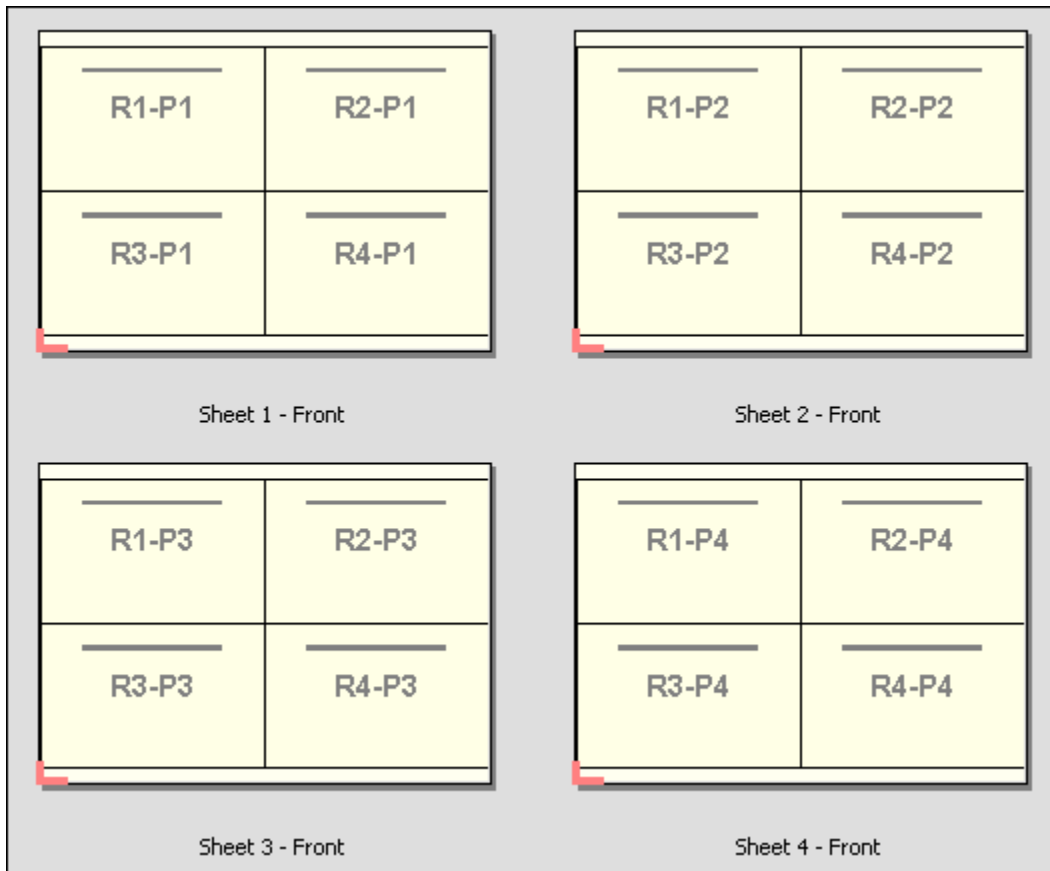

Cut and Stack

Cut and Stack arranges pages on the sheet surface so that the sheets can be stacked and cut, and the cut piles stacked without any additional sorting. The Cut and Stack layout can be used with the Stack Size option.

The following example shows a 2-by-2, simplex, Cut and Stack layout applied to a VDP job that contains 100 records. Each record consists of one page. When the sheets are stacked, cut, and stacked again, the records are arranged in sequential order.

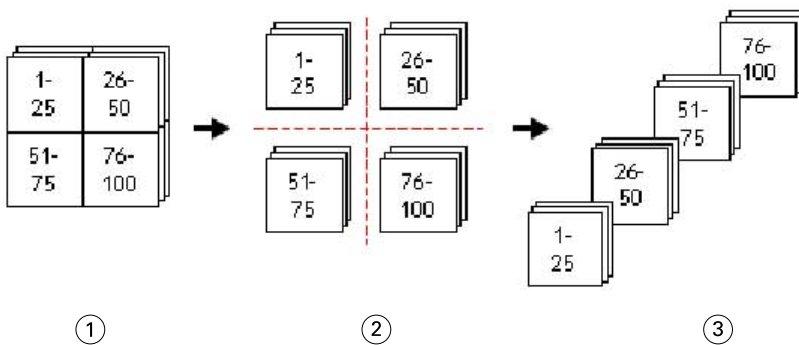

1	Print
2	Cut
3	Stack

Stack Size

Stack Size divides large VDP jobs into smaller batches to simplify the resulting Cut and Stack workflow. This lets you limit the stacked sheets to quantities that are accommodated by standard cutting machines. Each batch is imposed independently using the Cut and Stack layout, and separator sheets are placed in between the batches. (The Stack Size option is only available when you choose the Cut and Stack layout.)

The following example shows a 2-by-2, simplex, Cut and Stack layout applied to a VDP job that contains 12000 records, each consisting of a single page. This results in 3000 sheets. The Stack Size option is set to 1500 sheets per batch. The resulting layout consists of two batches, each of which can be cut, sorted, stacked, and packed in tandem.

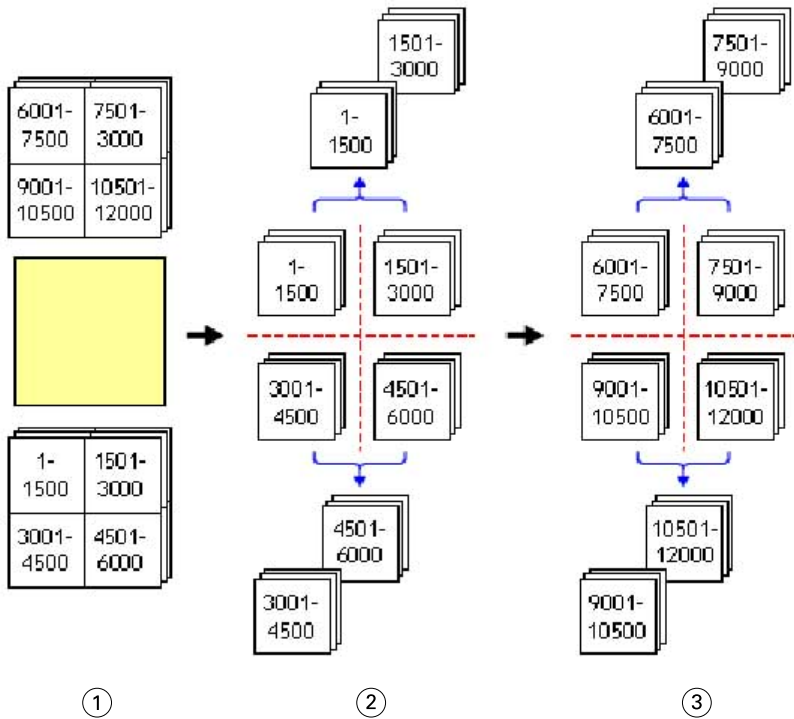

1	Print
2	Cut first pile and pack
3	Cut second pile and pack

Set Fiery Impose preferences

The Preferences dialog box lets you set the path to temporary files, defaults for converting PostScript to PDF, measurement units, application language, scaling, and the default finish size for imposed jobs.

You set Fiery Impose preferences in Command WorkStation > Edit > Preferences.

Set imposition scale and finish size

In Preferences, Scale sets the default scale factor when Fiery Impose starts. Finish Size is based on the PDF crop box or trim box settings. (Not all Fiery Servers support the Finish Size setting.)

- 1 Click Size.
- 2 For Scale, click 100% or Scale to fit.
- 3 For Finish size, click Based on Crop box or User Defined.
 - Based on Crop Box, the default and legacy Fiery Impose workflow, depends on the PDF crop box.
 - User Defined allows Impose to detect the trim box settings, when present within the document, and use these as the default finish size. It does not depend on document size and crop box.

Set paths to imposition files

The Paths pane in the Preferences dialog box lets you set paths to the default location for temporary files and preset templates.

- 1 Click Paths
- 2 Set the following:
 - For Temporary Path, set the default location for temporary files.
 - For Imposition Template Path, specify the folder for storing the preset template files.

Set PostScript conversion for imposition

In Preferences, you can set the default for converting PostScript to PDF. VDP imposition jobs do not support PostScript to Adobe PDF conversion.

- 1 Click Paths.
- 2 In the PS to PDF Conversion pane, select a default setting from the Default settings menu.

You can set additional job settings in Acrobat Distiller and add them to the list of available choices.
- 3 If you want, select Use server conversion, if supported.

Set imposition measurement units

You can set the unit of measurement to use in the Fiery Impose window. This setting does not affect predefined page size values.

- 1 Click Regional Settings.
- 2 If you want to set a default unit of measurement for all fields, click a measurement unit in the Units menu.

- 3 If you want to set a unit of measurement for any field that accepts input, enter a value in the field. You can enter **i**, **in**, or the inch symbol (") for inches; **mm** for millimeters; or **pt** or **pts** for points.

Set the application language

Use Regional Settings to set the application language.

- 1 Click Regional Settings.
- 2 For Application Language, set the language that Command WorkStation uses.

Preview a job for imposition

In the Command WorkStation Preview window, you can display sheet dimensions and navigate among the sheets of an imposed job.

When you select a job for imposition in Command WorkStation, the job opens in the Preview window. Jobs appear as thumbnails of the sheet in the Sheet View pane, either displaying the content or in wireframe view. Selecting a page in either view does not select the corresponding page in the other view.

For more information about previewing jobs in Command WorkStation, see [Fiery Preview](#) on page 68.

View and measure sheet dimensions

Use the Measurement tool to display basic sheet dimensions, to determine distance from a point of origin to a specific corner or edge of the page and sheet, and to change the point of origin (reference point).

- 1 Click the Measurement tool icon.
- 2 Move the cursor around a page to make predefined Hot Spots appear.
Hot Spots are indicated by a horizontal or vertical line of red dashes.
- 3 Press the Ctrl key (on Windows) or the Cmd key (on Mac OS X) and point and click to select a page.
The nine possible reference points for the page appear.
- 4 Point and click to select a desired reference point. When it is selected, the reference point appears as a red square.

View sheets of imposed jobs

You can view and navigate to the sheets of an imposed job by dragging or by sheet number.

- Do one of the following:
 - Drag with the Drag tool to scroll across the sheets of the job.
 - Click the Sheet number display at the bottom of the Sheet view and then enter a sheet number in the Go To Sheet dialog box.

Imposing a job

To impose a job, you open the job in the Preview window and apply a template.

Fiery Impose lets you choose from the predefined templates or create a custom template by changing the imposition settings and saving them. You can work in either wireframe view or thumbnail content view in the Sheet View pane.

You can also import your own templates or specify imposition settings.

If you specify imposition settings, you first choose one of four workflows (product intents):

- **Compose** - For specifying settings in Fiery Compose before printing. This is for working with documents with paper sizes defined by the printer driver and source application. Allows you to build a job using Fiery Compose features.
- **Normal** - For 1-up imposition where clipping and printer's marks may be required.
- **Booklet** - For creating booklets of various types.
- **Gangup** - For creating various gangup pagination schemes.

Fiery Server system pages are designed for administrative, informational purposes only. You cannot impose pages such as configuration, calibration, test pages, post-flight reports, and PANTONE books and charts.

Booklet Maker settings in Fiery Impose

You can use Fiery Impose to open a job with Booklet Maker settings, and then preview or modify the imposition layout. Fiery Impose translates and maps all Booklet Maker settings to Fiery Impose commands. See *Booklet Maker Help* in *Command WorkStation Help*.

Important: After you edit a job in Fiery Impose, you cannot edit it in Booklet Maker.

Imposition templates

Fiery Impose provides predefined templates. You can also create custom templates.

The predefined templates are Normal, Booklet, and Gangup:

- Normal includes Default Template and 1-up full bleed.
- Booklet includes 2-up perfect, 2-up saddle, and 2-up head to head.
- Gangup includes 3-up trifold brochure, 4-up gate fold, 4-up z Fold.

You can create a custom template by changing the settings in a predefined template. Click the lock icon to unlock the template, make changes, and save the template with a new name. (Not all settings may be available for custom templates.) The new settings are applied immediately.

In the Preferences dialog box, you can set a path to the folder or directory where you want to store custom templates.

Apply an Imposition template

You apply a custom template the same way as a predefined template.

- 1 Click the arrow to the right of the Template field at the top of the Settings pane to open the Template browser.
- 2 Click the icon for the template.

The new settings are applied immediately when you select a template.

Save a custom Imposition template

You can save a custom template if you have a licensed version of Fiery Impose. It is a good idea to use a descriptive name for the custom template.

- 1 Create a custom template.
- 2 Click the Save icon.
- 3 Type a name for the settings file in the Save Template dialog box.

Delete a custom template

You can delete a custom template. However, the currently selected job retains the deleted template settings until you select another template or specify new imposition settings.

- 1 Select the template you want to delete from the Template menu.
- 2 Click the Delete icon.

Save an imposed job

You can save an imposed job as a regular imposed job or "flattened" PDF on the Fiery Server or local disk.

Saving a job as a "flattened" PDF allows you to print the job or file on different printers that may not have a processor imposition capability. The flattened PDF can easily be sent to customers for remote signature level proofing.

Note: Impose cannot save a VDP imposition job in Adobe PDF format.

Save a job as a regular imposed job

When you save as a regular imposed job, you save the job to the Fiery Server with extension .dbp with the job ticket. You can then reopen the job and make changes.

- 1 Choose Save from the File menu.
- 2 Select Save as a regular imposed job and modify the Job Name if desired.

Save a job as a flattened PDF

When you save as flattened PDF job/file, you can save back to the Fiery Server or local disk and archive the imposed PDF for future reprinting.

Important: When saving as flattened PDF, Fiery Impose adds the extension .dbp to avoid overwriting the source file. To use a different extension and not overwrite the source file, give the job a new file name.

- 1 Choose Save from the File menu.
- 2 Select Save as a flattened PDF job/file and click Settings.
- 3 Set any of the following for Rotation and Security.
 - Rotation - for the Front and Back of the signature
 - Security - for the Adobe PDF
- 4 Choose one of the following:
 - Choose Job Name if you want to save the job as a flattened PDF file back to the Fiery Server.
 - Choose File Name if you want to save the job as a flattened PDF file to the local disk.

Imposition template reference

Fiery Impose provides predefined templates. The settings that a template covers depend on the specific template.

1-Up Full Bleed template

The 1-Up Full Bleed layout prints one page per sheet. The Printer's Marks indicate where to cut the paper so that the color content extends to the edge of the paper. The following settings apply for this layout:

- Bleeds
- Printer's Marks
- Scale to Fit
- Gang Up Unique

The 1-Up Full Bleed layout has no page number restrictions.

2-Up Perfect template

The 2-Up Perfect template creates signatures for a perfect-bound book, with each sheet folded once and stacked on top of one another. The following settings apply for this layout:

- Duplex
- Bleeds
- Printer's Marks
- Scale to Fit
- Perfect binding

The 2-Up Perfect layout is for jobs that have multiples of four pages, but you can use it with jobs that have any number of pages. Fiery Impose adds additional blank pages as necessary. Pages are ordered in groups of four so that, when folded, each sheet has four sequential pages.

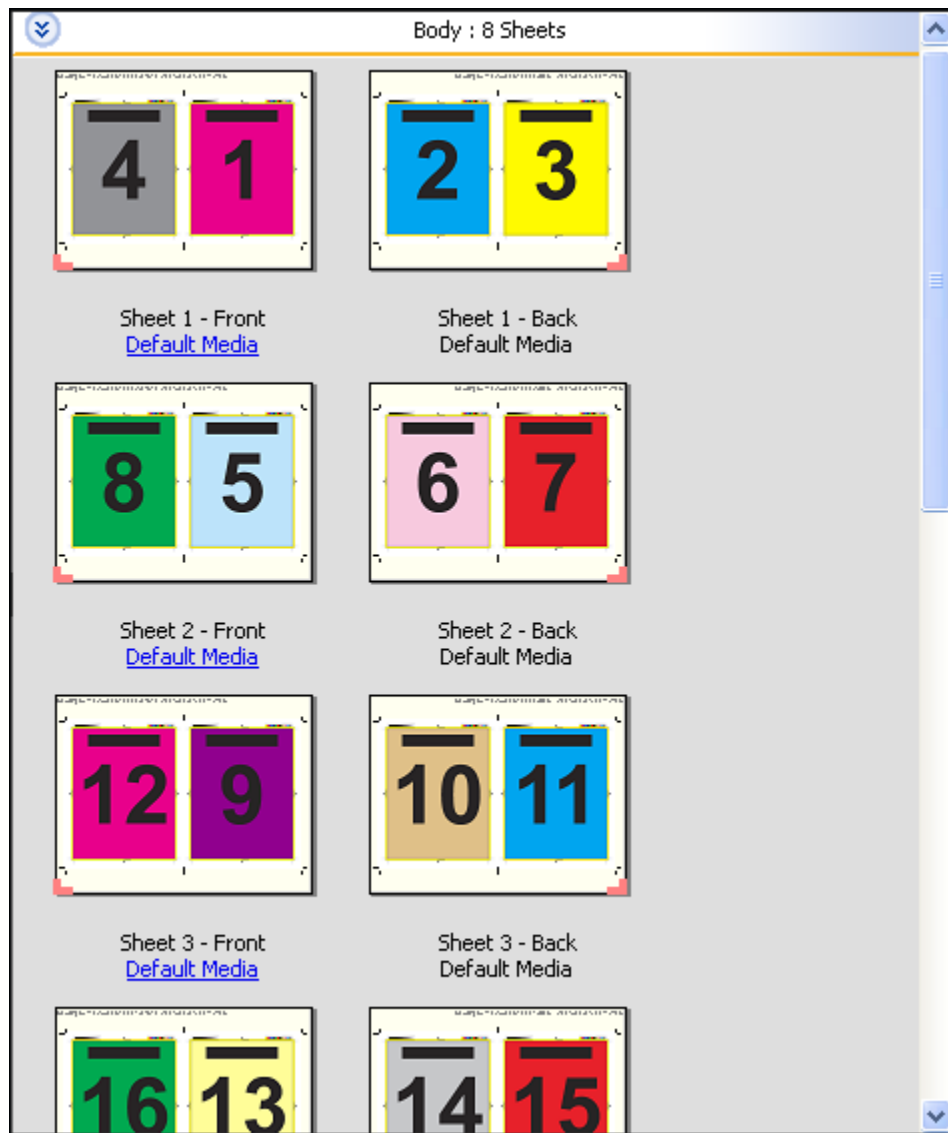

Note: The Creep Adjustment option has no effect on this template.

2-Up Saddle template

The 2-Up Saddle layout creates sheets for a saddle bound book. All of the sheets are folded together, one inside the other. The following settings apply for this layout:

- Duplex
- Bleeds
- Printer's Marks
- Scale to Fit
- Saddle Stitch Binding

The 2-Up Saddle layout is for jobs that have multiples of four pages, but it can be used with jobs that have any number of pages. Fiery Impose adds additional blank pages as necessary. Pages are ordered so that, when sheets are folded and stitched together, the pages are sequential.

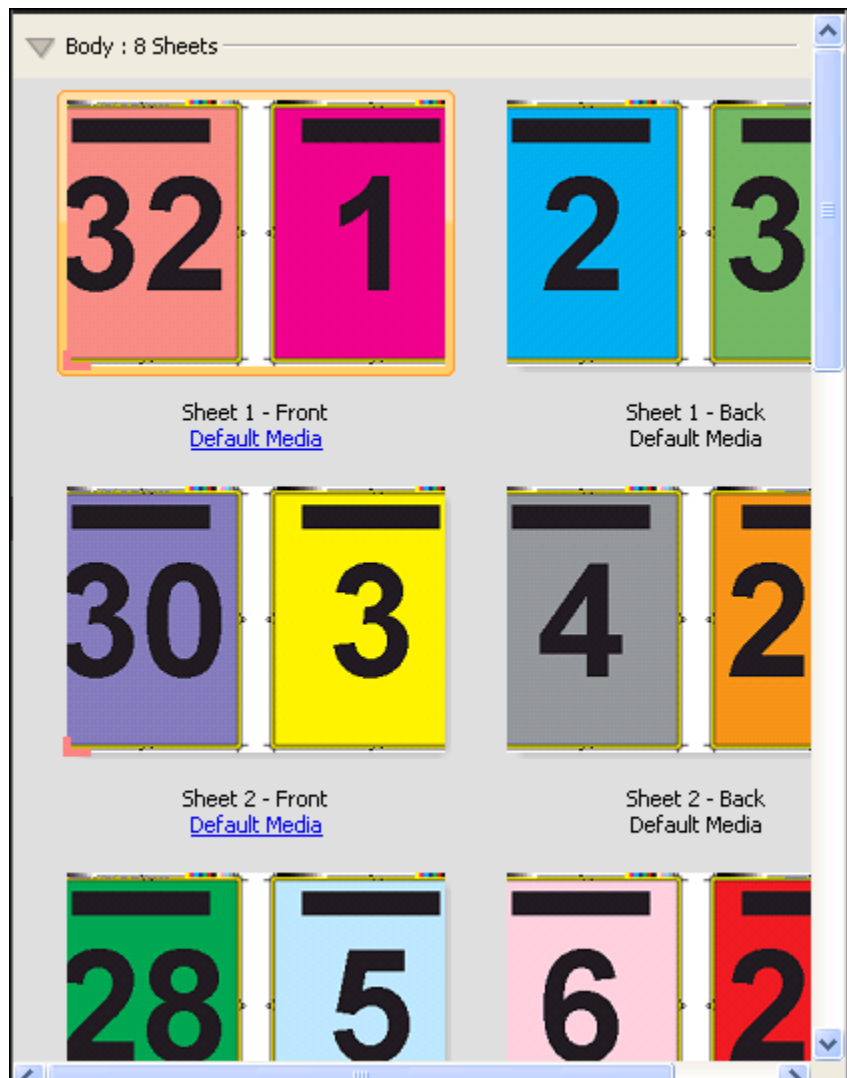

3-Up Trifold Brochure template

The 3-Up Trifold Brochure layout consists of a single sheet folded into three sections. Although the three sections are the same width, the space between each section varies so that the leftmost panel can be folded over the other two panels. The following settings apply for this layout:

- Duplex
- Printer's Marks
- Scale to Fit
- Gang Up Unique

The 3-Up Trifold Brochure layout is for jobs that have six pages or multiples of six pages, but you can use it with jobs that have any number of pages. Fiery Impose adds additional blank pages as necessary.

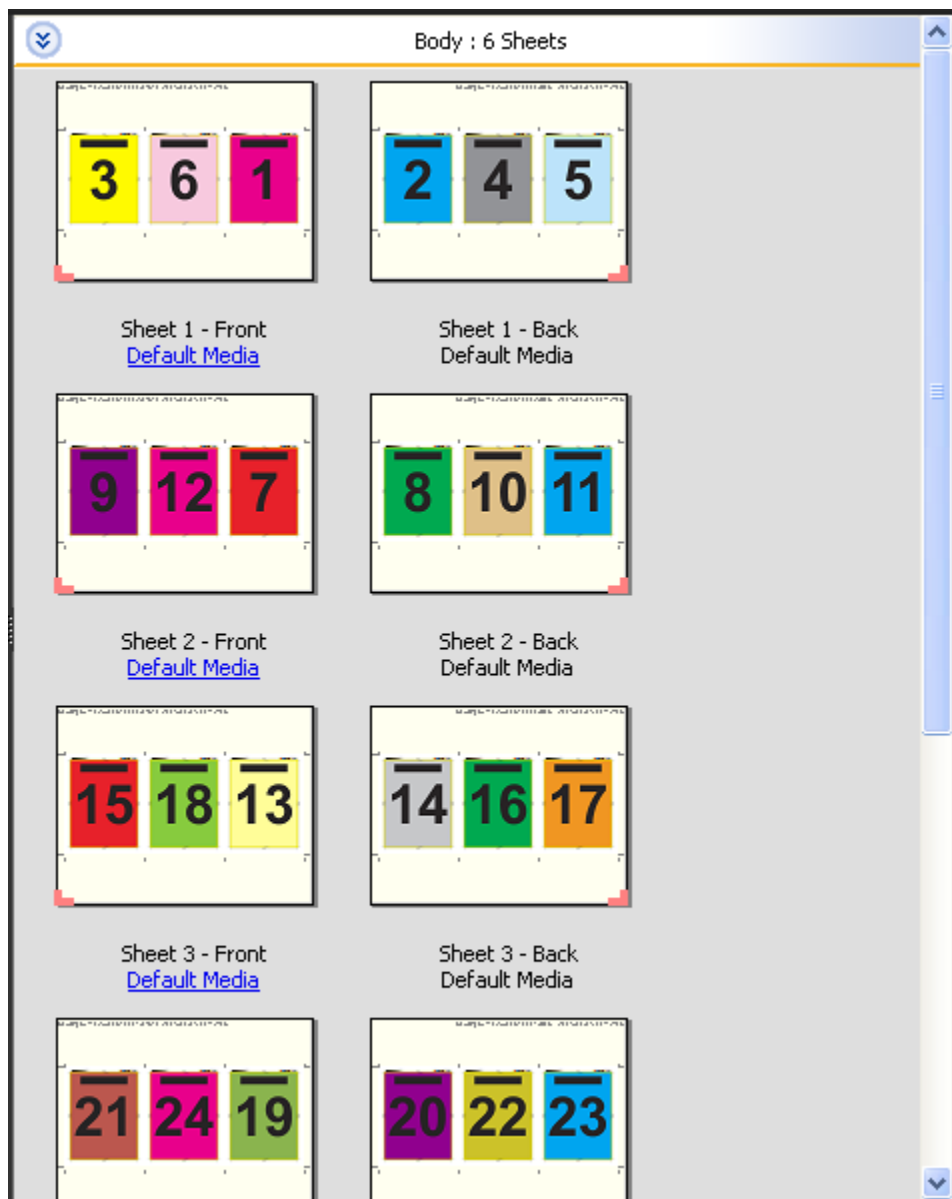

The 3-Up Trifold Brochure is usually folded as shown in the following illustration.

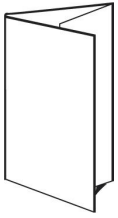

4-Up Gate Fold template

The 4-Up Gate Fold layout is used most often for a four-panel brochure. The finished brochure unfolds to double, then four times the original size. The following settings apply for this layout:

- Duplex
- Bleeds
- Printer's Marks
- Scale to Fit
- Gang Up Unique

The 4-Up Gate Fold layout is for jobs that have multiples of eight pages, but you can use it with jobs that have any number of pages. Impose adds additional blank pages as necessary.

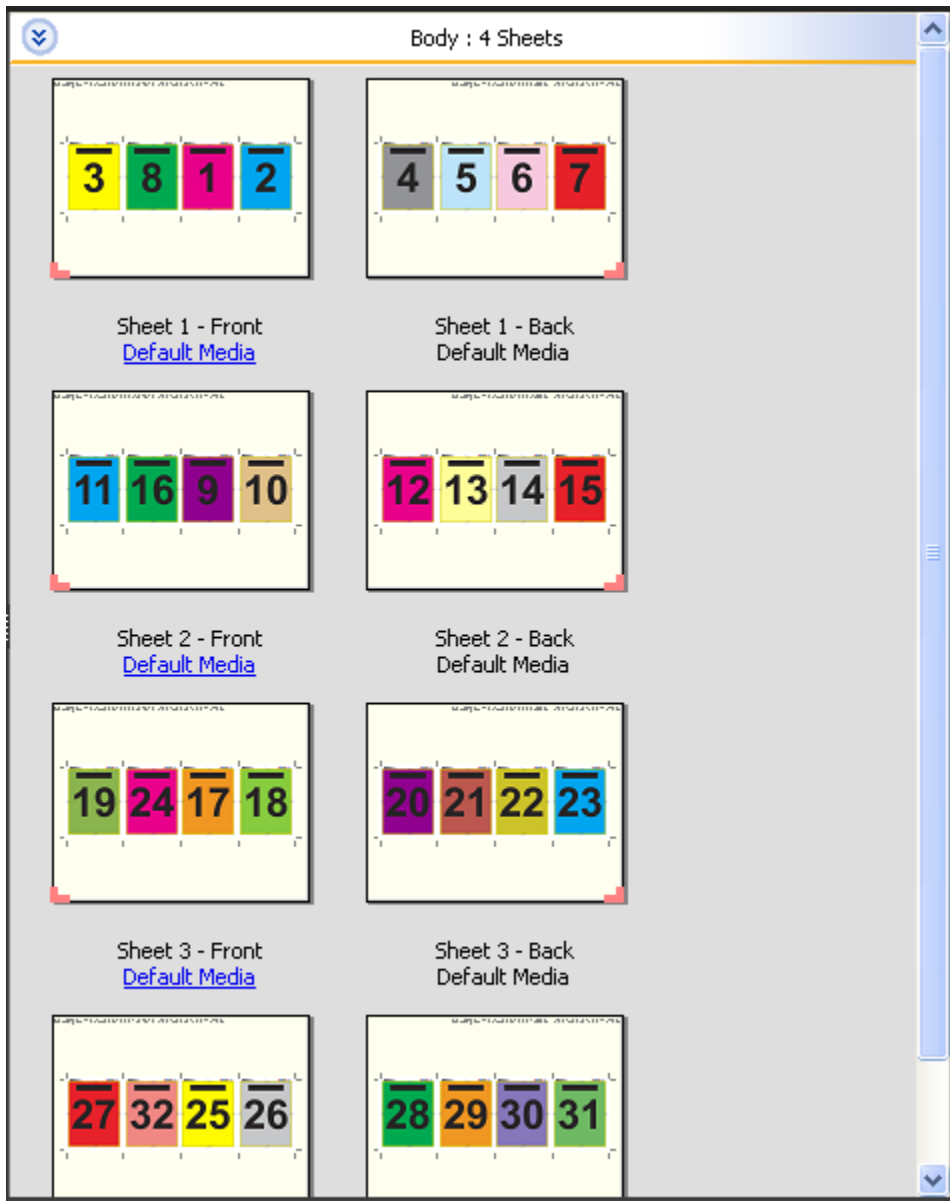

The 4-Up Gate Fold is usually folded as shown in the following illustration.

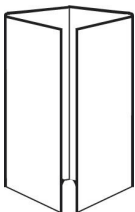

4-Up Head to Head template

The 4-Up Head to Head layout is for booklets created from a layout of four pages on each side of the printed sheet. Rotating the two topmost pages lets you fold the signature both horizontally and vertically, and trimmed. The finished booklet has all pages in the correct order and rotation.

The following settings apply for this layout:

- Duplex
- Bleeds
- Gutters
- Printer's Marks
- Scale to Fit
- Saddle stitch binding

The 4-Up Head to Head layout is for jobs that have multiples of eight pages, but you can use it for jobs that have any number of pages. Fiery Impose adds additional blank pages as necessary. Pages are ordered so that, when sheets are folded with two folds at 90 degrees, trimmed, and stitched together into signatures, the pages are sequential.

Note: Although this layout requires two folds, the template applies a fold mark on the spine fold only. For example:

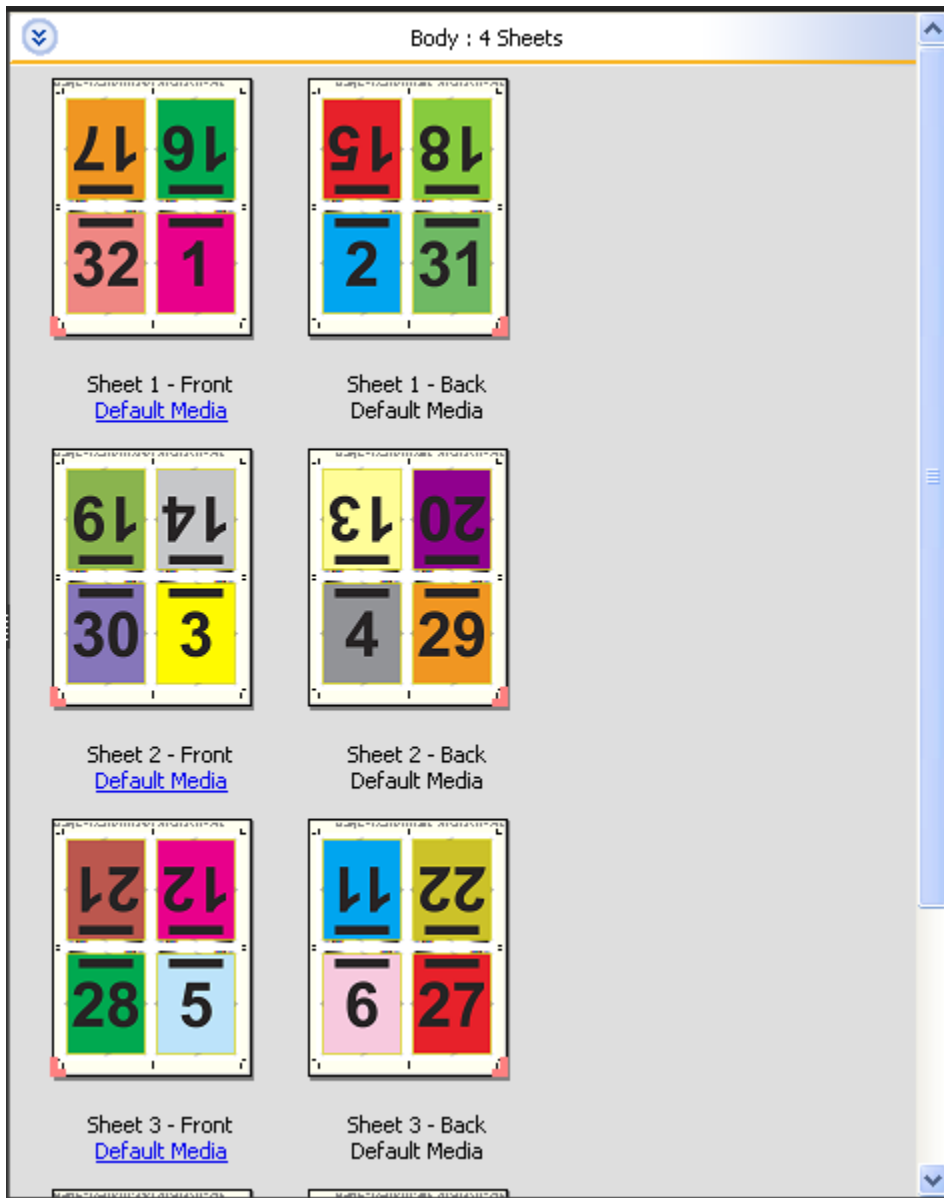

The 4-Up Head to Head is usually folded as shown in the following illustration. If you are folding more than one sheet, you must stack all the sheets and fold them together.

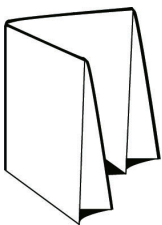

4-Up Z-Fold template

The 4-Up Z-Fold layout lets you fold many panels on top of one another without stressing the folded spine. A common example is a road map. The following settings apply for this layout:

- Duplex
- Printer's Marks
- Scale to Fit
- Gang Up Unique

The 4-Up Z-Fold layout is for jobs that have eight pages, but you can use it with jobs that have any number of pages. Fiery Impose adds additional blank pages as necessary.

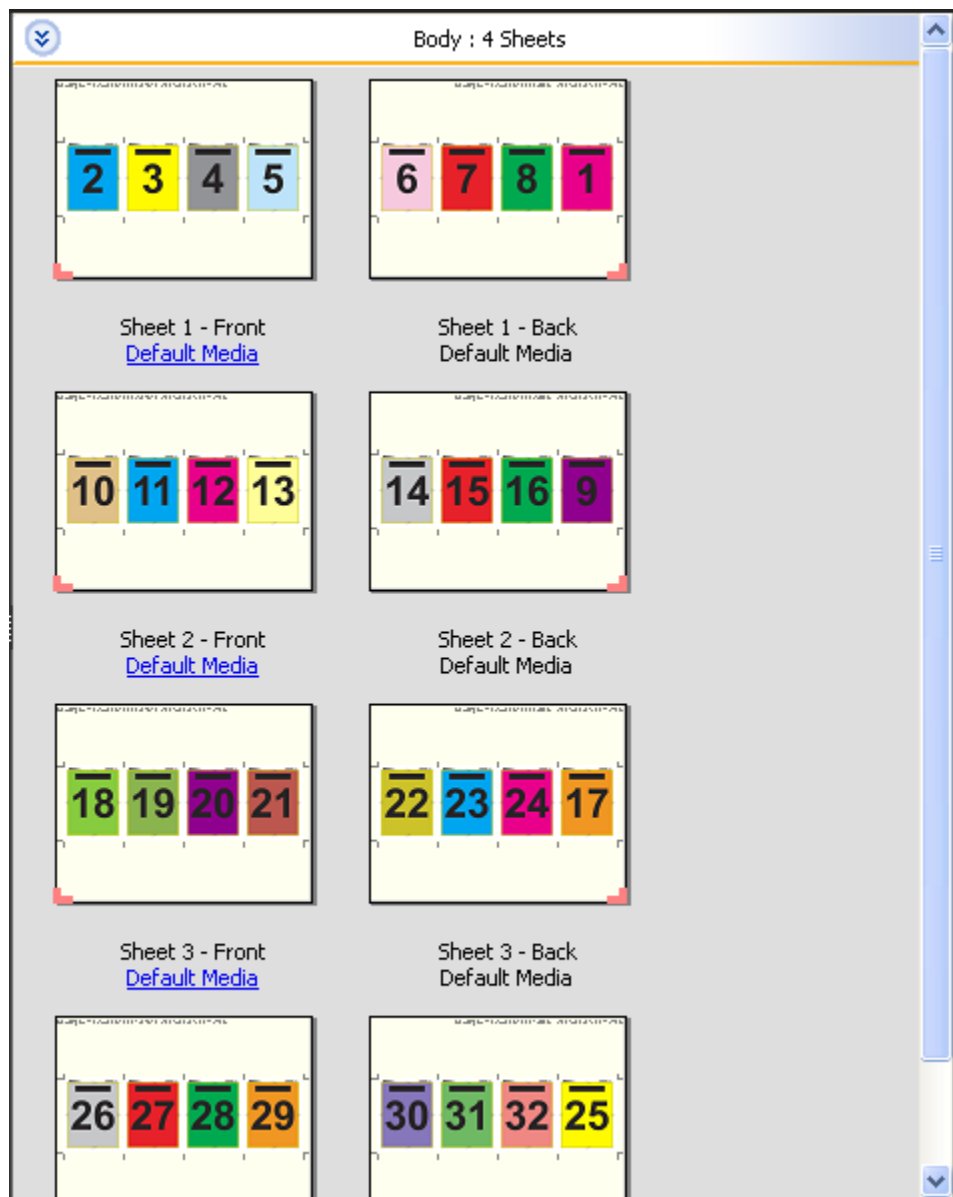

The 4-Up Z-Fold is usually folded as shown in the following illustration.

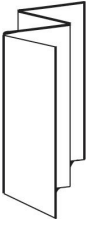

Choose a product intent workflow

Fiery JobMaster-Fiery Impose-Fiery Compose supports a variety of workflows (product intents). When you choose a product intent, the Settings pane changes to show the options relevant to that product intent.

- 1 Click the arrow in the product intent box at the top of the Settings pane.
- 2 Click Compose, Normal, Booklet, or Gangup. Then choose from the options that appear.

Several of the intents include a Finish Size setting, which allows you to choose between a crop box workflow and a user-defined workflow. If the Finish Size setting is *not* displayed, the user-defined workflow is not supported by your Fiery Server, so the default workflow—the crop box workflow—is used.

Imposition settings

Fiery Impose lets you set print job options including finish size, sheet size, duplex, scaling, cover media, layout orientation, bleeds, and printer's marks.

The settings that are displayed in the Settings pane are determined by the product intent you choose. See [Choose a product intent workflow](#) on page 38.

For a description of the templates available for each product intent, see [Imposition templates](#) on page 26.

Finish size options for Fiery Impose

Finish Size sets the size of the final product after printing and applying finishing processes such as trimming, folding, or binding.

If the Finish Size setting does not appear, the Fiery Server does not support the user-defined workflow described below. The default workflow is the Crop Box option.

The two possible workflows are:

- **Based on Crop Box** - The layout of the job is referenced to the Adobe PDF crop box. You must manually set the bleed size for the selected document page content, and specify the trim marks. In this workflow, you must manually estimate the finish size of the final product by subtracting bleed size from the size of the crop box.
- **User Defined** - The final finish size and bleed size are automatically detected for the PDF job, but you can change both settings. The page content is aligned in the center of the media. In the User Defined workflow, the finish size is a static value independent of bleed, crop box, or document page size. The original bleed sizes are automatically detected, as are the placement of the trim marks.

The minimum dimension you can enter for the final finish size is 0.25 inch. The maximum depends on the paper size supported by the printer.

Advantages of the User Defined Finish Size

The user-defined finish size is based on the trim size specified in the original content. You specify the finish size and Fiery Impose automatically positions the page content in the center of each sheet.

Fiery Impose also automatically sets the default bleed size and the placement of the trim marks. If the job being imposed comprises content positioned differently on each page, each with a different crop size, selecting the user-defined finish size allows Fiery Impose to automatically pick up the trim size set in the Adobe PDF.

With the crop box workflow, the user must figure out the bleeds and the trim marks and do some manipulation to place the page content correctly for the imposition layout.

Set sheet size in Fiery Impose

The default Sheet setting applies to all sheets (signatures) and defines the dimension of the intended imposition layout. Special sheet size assignments can be defined in Paper Catalog or Mixed Media in Job Properties.

- 1 Click the arrow to the right of the Sheet field box to set the dimensions of a sheet of paper.
- 2 Click Edit to specify other media settings, such as weight, color mode, coating, and tab shift.
- 3 If Paper Catalog is supported, click the arrow to the right of the Media box to choose from the Paper Catalog menu.

Set Duplex in Fiery Impose

Duplex sets how to handle content on opposing sides of a sheet. You can set duplex for right and left binding, top binding, or turn duplex off. Duplex options depend on the Fiery Server you connect to.

Fiery Impose automatically applies duplex settings for the selected booklet style and binding. The Duplex setting in Fiery Impose overrides any Duplex setting performed in Command WorkStation Job Properties.

- Click one of the following:
 - Off - Turns off duplex printing and uses simplex printing.
 - Right & Left Binding - Sets duplex printing with both sides of the pages printed with the same orientation.
 - Top Binding - Sets duplex printing with the content on the each side of the page oriented upside down from the other side. Top binding is not available for all jobs.

Note: Duplex does not necessarily appear in Sheet View with the orientation it will have when printed. For example, top binding duplex is displayed as both sides of the page right-side-up.

Scale settings in Fiery Impose

Scale settings enlarge or shrink the page by a specified amount.

In Compose and Normal product intents, the Scale settings apply to all pages in a job. In Booklet and Gangup product intents, you can apply scaling to specific slots on sheets. The number of slots on a sheet depends on the Row and Column values. The slot size equals the maximum imageable area of the sheet divided by the number of slots.

The User-Defined Finish Size workflow provides more scale options than the Crop-Box Finish Size workflow.

The Use non-printable area option uses the selected sheet's full physical dimensions for imposing your print job. This is helpful when creating custom templates that you may want to use with a variety of print engines. When this option is *not* selected, Fiery Impose determines position and scale factor of the imposed job by the imageable area of the final printed sheet, according to the printer. This constraint may prevent a custom template being used with another printer.

Note: The Rows and Columns value interacts with the Scale settings. If you choose a value that causes content to extend beyond the edge of the sheet, Fiery Impose provides a visual warning.

Specify Scale settings

The Based on Crop Box finish size workflow (the default workflow) allows you to specify scaling, scale to fit, or prevent scaling. The User Defined finish size workflow provides more scaling options, letting you fit or fill the page image to the static boundary of the finish size or bleed.

- 1 Choose a setting from the Scale menu.
- 2 If you chose Custom, type a scale value in the text box.
- 3 To use the selected sheet's full physical dimensions for imposing your print job, select the Use non-printable area checkbox if it is available.

Set cover media

You can set whether to include a cover and specify its settings.

- 1 Click the Cover check box to include a cover.
- 2 Click Define to specify media settings.

Choose whether to apply the same settings for both front and back covers, specify settings only for the front cover, or specify separate settings for the front and back covers.

Set the layout orientation

Use the Layout Orientation menu in the Settings pane to specify the orientation of a sheet.

- 1 Click Portrait or Landscape in the Layout Orientation menu.
- 2 If the booklet style is Nested Saddle, specify the subset size, which is the number of sheets within each subset.

The number of sheets for the last subset is not a fixed number, and Fiery Impose adjusts the sheets needed according to the actual page count of the job. The default setting for Subset Size (sheet/subset) is 2 and the maximum setting possible is 15.

Bleeds for workflows in Fiery Impose

How Fiery Impose applies bleeds depends on the workflow you set.

- For the Crop Box finish size workflow, the Bleeds option moves the trim marks into the image by the amount you specify to ensure that the printed area extends beyond the edge of the trimmed sheet. You can specify separate bleed amounts for the left/right (horizontal) and top/bottom (vertical) edges of the page content.
- For the User Defined finish size workflow, the Bleeds option represents the amount of page content to be shown beyond the boundary of the finish size. The trim marks adjust automatically and remain aligned to the edge of the finish size. When a job is opened in Fiery Impose and the User Defined option is set for finish size, the dimensions of the finish size and the bleeds are automatically entered, but you can change the settings.

Set bleeds

Fiery Impose lets you set horizontal and vertical bleeds.

- Do one of the following:
 - To specify separate horizontal and vertical bleed amounts for a job, enter values from 0 to 720 points, 0 to 10 inches, or 0 to 254 mm in the appropriate fields.
 - To apply the same bleed values to all four edges of the page content, click the **Apply Both** check box and type a value.

Set printer's marks in Fiery Impose

Fiery Impose lets you set printer's marks. You can also turn on or turn off marks and individual elements of the job label.

- Use printer's marks to add trim, fold, and job information to all sheets in a job. The printer's marks option turns printer's marks on globally throughout a job. Layouts display only the relevant printer's marks. If the layout does not require folding the sheet, fold marks are not displayed, even if you selected them.
- Use the Marks dialog box to turn on or turn off trim marks, fold marks, and the individual elements of the job label.

Note: Printer's marks in the User Defined finish size workflow always align to the edge of the finish size.

Define printer's marks

You use the Marks dialog box to set printer's marks.

- 1 In the Settings pane, click **Define** to open the Marks dialog box.
- 2 Use the **Trim**, **Fold**, **Job Label**, **Blank Text**, and **Registration and Barcode** tabs to specify settings.

Note: The Job Label for VDP jobs displays different information than for non-VDP jobs.

Set Trim marks

Use the Trim tab to set trim marks.

- 1 Click the Trim tab.
- 2 Select the **Print trim marks** checkbox.
- 3 Do any of the following:
 - Set the horizontal and vertical mark length from 1 to 216 points.
 - Set dotted or solid for Stroke type.
 - Set Stroke width from 1/4 to 3 points.

- Set Stroke color.
 - In the Horizontal Offset and Vertical Offset fields, enter values from -72 to $+72$ points, -1.0 to 1.0 inch, or -25.4 to 25.4 mm.
- 4** To disable or enable an individual mark, press the Ctrl key (on Windows) or Cmd key (on Mac OS X) and click the mark in the Fiery Impose window.

An "X" indicates a mark is disabled.

Set Fold marks

The Fold tab lets you set fold mark length and appearance, and disable individual marks.

- 1** In the Marks dialog box, click the Fold tab.
- 2** Select the Print fold marks checkbox.
- 3** Set any of the following:
 - Set the horizontal and vertical lengths of marks from 1 to 216 points.
 - Set Stroke type of Fold marks to either dotted or solid.
 - Set Stroke width of Fold marks from $1/4$ to 3 points.
 - Set the Stroke color.
- 4** To disable or enable an individual mark, press the Ctrl key (on Windows) or Cmd key (on Mac OS X) and click the mark in the Fiery Impose window.

An "X" indicates a mark is disabled.

Set job label attributes

The Job Label tab lets you set job label content and location. (Job label content for VDP jobs differs from non-VDP jobs.)

- 1** Click the Job Label tab.
- 2** Click checkboxes (such as Job Name and Sheet Info) to display the associated information on the job label.

Sheet info for standard jobs includes the sheet number and the surface information (front/back).

For VDP jobs, you can also click the Output sheet number checkbox, which displays the absolute sheet number. If the total number of printed sheets is 500, the absolute sheet number is from 1 to 500.
- 3** Click the area where you want to place the label.
- 4** Click Horizontal or Vertical to set whether the job label is placed horizontal or vertical on the sheet.
- 5** If desired, enter offset X and Y values.

The offset is measured from the point of origin.

Set blank page text

Use the Blank Page Text tab to set what appears on implicit blank pages.

- 1 Click the Blank Page Text tab.
- 2 Enter text you want to appear on any implicit blank pages.
- 3 Select Print blank page text.

Set registration marks and barcode in Fiery Impose

Your imposed layout can include a registration mark, a barcode, or both. These options allow automatic drift compensation and machine setup for the Duplo offline finisher.

The registration mark position determines the leading edge of the sheet, as the Duplo finisher requires the mark to be on the right of the leading edge of the upper surface of the sheet.

- 1 In the Marks dialog box, click the Registration and Barcode tab.
- 2 Click one of the following in the Print field:
 - Do not print, which is the default
 - Registration mark only
 - Barcode only
 - Registration mark and barcode
- 3 If you set Registration mark only, set the following:
 - Position - The location of the registration mark on the sheet.
 - Mark length and Mark width - The possible length is from 5 to 10 mm. The possible width is from 0.4 to 1.6 mm.
 - Mark Offset - Vertical and horizontal offset for the mark position. The default for both feed edge and right edge is 5 mm. The possible range is 3 to 15 mm for each.
 - Layout Offset - Amount to move the layout away from the feed edge of the sheet to accommodate the registration mark and barcode. The possible range is 0 to 30 mm.
- 4 If you set Barcode only, set the following:
 - Position - Barcode location on the sheet.
 - Barcode Type - The barcode font.
 - Barcode Text - A 2-digit number from 01 to 80.
 - Print Text - Prints the numerical representation of the barcode on the sheet.

- **Mark Offset** - Vertical and horizontal offset for the barcode position. The default for feed edge is 5 mm, and the possible range is 3 to 15 mm. The default for right edge is 25 mm, and the possible range is 25 mm to 42 mm.
 - **Layout Offset** - Amount to move the layout away from the feed edge of the sheet to accommodate the registration mark and barcode. The possible range is 0 to 30 mm.
- 5** If you specified Registration mark and barcode, specify the settings in the Registration pane as described in step [3](#).
The settings apply for both Registration marks and barcode. In the Barcode pane, specify the text and whether to print the text.
 - 6** Set Print mark on front surface of sheet only, if required.

Specify booklet settings in Fiery Impose

Booklet settings include binding settings for booklet product intent, rows and columns, and creep (the shift of the content area caused by the incremental fold of signatures in Saddle and Nested Saddle binding).

Specify binding settings for Booklet

You can specify a binding method and edge options. The binding method affects the order in which pages are placed on the sheet. (There are no binding selections available for layouts with more than two columns or rows.)

1 Set one of the following binding methods:

- Saddle
- Nested Saddle
- Perfect

2 Set one of the following binding edge options:

- Left binding
- Right binding
- Top binding

Note: Top edge binding is available only when the layout setting is either 2 rows x 1 column or 2 rows x 2 columns.

Specify row & column settings for Booklet

For booklet Row & Column settings, you can specify 1X2, 2X2, or 2X2 Repeat booklet.

1 Click the arrow to the right of the Row & Column box to display the menu.

2 Select 1X2, 2X2, or 2X2 Repeat Booklet.

Which settings are available depend on the binding style.

3 Click Align to Center to define the initial placement of the page content.

If specifying a creep setting, and selecting In, you can use Align to Center to help space the imposed page or specify a gutter to indicate the amount of creep.

Specify Row & Column settings for Gangup

You can specify up to 25 rows and columns for Gangup.

- Use the arrows to select a number up to 25, or type the desired value in each field.

Specify Creep settings

For Creep, you set a direction and sheet thickness.

- 1** In the Creep menu, select one of the direction settings (or None).
 - **In** - The positions of pages on the most outer sheet remain constant. The positions of the remaining pages on all other sheets move toward the spine.
 - **Out** - The positions of pages on the most inner sheet remain constant. The positions of the remaining pages on all other sheets move away from the spine.
- 2** Set sheet thickness by doing one of the following:
 - Click an option in the creep adjustment menu.
 - Enter a custom thickness value between 0 and 2 pts (or the equivalent in another measurement unit).

Specify Gangup settings in Fiery Impose

You can specify gangup styles, page order, gutter size, and gangup method.

Make sure that the gangup style and method can be used together. For details about which you can combine, see [Combining Gangup styles with Gangup methods](#) on page 50.





Set Gangup style

You can set gangup style.

- In the menu under the Template menu, click Unique, Repeat, Unique-Collate Cut, Duplo-Short Edge Feed, or Duplo - Long Edge Feed.

Set Page Order

The Page Order options allow you to specify the flow direction of pagination within the layout.

- Click one of the following in the Page Order section of the Settings pane:
 -  - Orders pages from left to right horizontally, by row, starting with the top row.
 -  - Orders pages from right to left horizontally, by row, starting with the top row.
 -  - Orders pages from top to bottom vertically, by column, starting with the furthest left column.
 -  - Orders pages from top to bottom vertically, by column, starting the furthest right column.

Set Gutters

You can set gutters for gangup jobs. Gutters are extra margins that allow space for binding or other finishing options. Fiery Impose defines the locations of gutters for you according to the layout and sheet size governing the imposition of the job. For example, perfect-bound jobs typically require larger gutters than saddle-stitched jobs, in order to provide room for grinding off the spines and gluing signatures together when the book is bound.

- 1 Click Define in the Gutter option.

- 2 In the Gutter dialog box, set the gutter measurement by typing in the available text entry fields for each gutter in your layout.
- 3 If you entered a value in one of the fields and want all gutters to have the same measurement, click Apply All.
- 4 If you selected Scale to Fit before setting gutters in the Gutter dialog box, use the "Scale to fit" uses gutter settings check box to control the placement of the page content.
 - Not selecting the check box (default setting) - Scale to Fit does not include the gutter size in the calculation. Changing the gutter size does not scale the page content, and instead shifts the content.
 - Selecting the check box - Scale to Fit includes the gutter size in the calculation. Changing the gutter size scales the page content to fit within the area defined by the rows and columns and gutter settings.

Scale to fit options with gutters

Fiery Impose offers two different Scale to Fit behaviors with gutters.

Scale to Fit is needed when the original page does not fit entirely within the available imposition slot on the sheet. The imposition slot size is defined by the sheet size and the number of imposition slots on the page (a function of the numbers of rows and columns). The gutter setting defines the space between the imposition slots.

If you have selected Scale to Fit, the Gutter dialog box offers a "Scale to fit" uses gutter settings check box. The behavior of the check box is as follows:

- Not selecting the check box (default setting) - Scale to Fit does not include the gutter size in the calculation. Changing the gutter size does not scale the page content, and instead shifts the content.
- Selecting the check box - Scale to Fit includes the gutter size in the calculation. Changing the gutter size scales the page content to fit within the area defined by the rows and columns and gutter settings.

If the user selected Scale to Fit, changing the gutter size automatically changed the scaling. The document was resized so it continued to fit in the available area. Note the following: The user selected Scale to Fit option so the page always fitted within the available imposition slot, no matter the gutter size or sheet size. Changing rows and columns or sheet size affected the scaled size. Changing gutter size affected the scaled size. Scale to Fit scaled down, not up.

Set Gang Up methods in Fiery Impose

You can set one of five Gang Up methods. Not all Gang Up methods and styles are compatible.

- Click one of the following Gang Up methods in the Layout Style menu:
 - Standard
 - Head to Head
 - Foot to Foot
 - Reversal
 - Reversal-Alternate

Combining Gangup styles with Gangup methods

Which Gangup styles and methods you can use together depends on whether the job format is PostScript, PDF, or VDP.

The following table shows which Gangup styles and methods you can use together for normal jobs in PostScript or PDF format.

Gangup styles	Standard	Head to Head	Foot to Foot	Reversal	Reversal Alternate
Repeat	Yes	Yes	Yes	Yes	Yes
Unique	Yes	Yes	Yes	Yes	Yes
Unique-Collate Cut	Yes	Yes	Yes	Yes	Yes

The following table shows which gangup styles and methods you can use together for VDP jobs.

Gangup styles	Standard	Head to Head	Foot to Foot	Reversal	Reversal Alternate
Repeat	Yes	No	No	No	No
Unique	Yes	Yes	Yes	Yes	Yes
Unique-Collate Cut	Yes	Yes	Yes	Yes	Yes
Multi-Record Collate	Yes	Yes	Yes	Yes	Yes
Cut and Stack	Yes	Yes	Yes	Yes	Yes
Duplo - Short Edge Feed	Yes	No	No	No	No
Duplo - Long Edge Feed	Yes	No	No	No	No

Standard style is the only layout style supported for variable data printing gangup repeat jobs. All layout styles are supported for non-variable data printing jobs in PostScript or PDF format submitted to Command WorkStation through the Import function or printer driver. For jobs submitted through Hot Folders, Fiery Impose cannot distinguish between variable data printing and non-variable data printing jobs, so Standard is the only Gangup repeat style supported for variable data printing and non-variable data printing jobs.

Specify Repeat Booklet finish feature

The Repeat Booklet, which is for off-line finishing, not in-line finishing, allows step-and-repeat printing of two identical booklets on one sheet. Repeat Booklet requires a layout of 2 rows by 2 columns.

- 1 Select Booklet for the product intent.
- 2 Select 2 X 2 Repeat booklet in the Row & Column option.

Styles available for edge-binding options

The following table shows which Style settings can be used with the edge binding options. These are applicable for PostScript or PDF jobs, but not for VDP jobs.

Note: For the Repeat Booklet binding layout, the Style setting modifies the orientation of the booklets. For Gang Up layouts, the Style setting modifies the orientation of the pages.

Binding Method	Standard	Head to Head	Foot to Foot	Reversal	Reversal Alternate
Left Edge Binding	Yes	Yes	Yes	No	No
Right Edge Binding	Yes	Yes	Yes	No	No
Top Edge Binding	Yes	No	No	Yes	Yes

Modify pages manually in Fiery Impose

When you use Fiery Impose, you can manually rotate, edit reorder, insert, and delete pages.

Rotate pages

In the Sheet View pane, you can only rotate pages in wire frame mode.

- Do any of the following:
 - To rotate a single page, click the Rotate icon on that page.
If you zoomed out too far, you may not see the Rotate icon. You can zoom in until the icon becomes visible.
 - To rotate all pages in the job, press the Shift and Ctrl keys and click the Rotate icon on any page.
 - To rotate all pages in a certain location on the front side of each duplex sheet, press the Shift key and click the Rotate icon on any page in that location on any sheet.
 - To rotate all pages in a certain location on the front and back sides of each duplex sheet, press the Ctrl key (Windows) or Cmd key (Mac OS X) and click the Rotate icon on any page in that location on any sheet.

Edit page content

The Enfocus PitStop plug-in for Adobe Acrobat lets you edit the content of pages in a job.

Before you begin

Important: Edit page content before performing sheet-level operations such as adding, duplicating, or deleting sheets. Editing page content cancels all previous sheet-level operations.

- To see the PitStop documentation, click Help > Plug-In Help > Enfocus PitStop Professional in the Acrobat menu.

Edit page content with PitStop

The Enfocus PitStop plug-in for Adobe Acrobat lets you edit the content of pages in a job.

- 1 Right-click a sheet in the Page View pane, and then choose Edit Page.
- 2 Use the PitStop editing tools to edit the document content.

Reorder pages

You can reorder individual pages manually by arranging them in the main window.

- In the Page View pane, select the thumbnail you want to move, and then drag the page to its new position.

Insert blank pages manually

You can add a blank page to your layout.

- Select the page in the Page View pane where you want to add a page, and then click the Insert Blank Page icon in the Page View toolbar.

Delete pages

You can quickly delete pages.

- Right-click a page in the Page View pane and choose Delete from the menu that appears.

VDP in Fiery Impose

In Fiery Impose, Variable Data Printing (VDP) imposition uses many of the features available for a normal imposition job. However, there are differences between VDP and normal imposition, and differences in the Fiery Impose window.

A Variable Data Printing (VDP) job consists of one or more variable-data records.

Fiery Impose lets you impose jobs saved in any of the following VDP formats:

- FreeForm 1.0 and FreeForm 2.1 (FreeForm 2.0 is not supported.)
- VPS
- PPML
- PDF/VT

You can impose VDP jobs using predefined templates or custom templates created in Fiery Impose.

When you apply a template to a VDP job, the template's imposition layout is applied in sequence to each record in the job.

- Each record begins on a new sheet.
- If a record does not fill the sheet completely, Fiery Impose inserts one or more blank pages to compensate for remaining slots on the sheet surface.
- The number of pages in each record can vary. Fiery Impose inserts blank pages to compensate for differences in page length among records.

Open or preview a VDP job

You can open a VDP job from the Job Center Held list. To preview a processed VDP job, use the Raster Preview window.

- Do one of the following:
 - To open a VDP job, right-click it in the Job Center Held list.
 - To preview an open VDP job, use the Raster Preview window (Actions > Preview).

Previews include any imposition settings applied to the job. The job content display is actual size, organized by records or finished sets.

Imposing a VDP job

Imposition settings apply to each page of the VDP job. Many VDP imposition settings are similar to those for a non-VDP job.

Note: Normal, Booklet, and Gangup are the workflows (product intents) available for VDP imposition. Compose is not available.

When you impose a VDP job, note that:

- The Sheet Size menu lists all the paper sizes supported by the Fiery Server and determined by the printer.
- The Template menu lets you select a predefined template or a non-VDP custom template created with Fiery Impose.
- To create a custom template in the VDP Imposition window, you must define all imposition parameters. You cannot copy and modify an existing template to create a custom template.

Print control strips for VDP jobs

A control strip identifies absolute surface number, output-set number, surface number relative to start of output-set, and logical pages for each record.

- Click Marks and then click Define.

Specify booklet, scale, or bleeds for VDP imposition

VDP imposition settings for multi-up booklet, bleeds, and scale differ slightly from the settings for a standard Fiery Impose job.

Set multi-up booklet for VDP jobs

You can specify a 2 x 2 Unique Booklet when you select Saddle for a VDP job. (This lets you print two records on a sheet.) For records of different lengths, Fiery Impose automatically adds blank pages based on pagination requirements.

You can save the settings as a preset that you can select from Virtual Printers or Hot Folders.

- 1 Select a job in the Held list in Command WorkStation, and then click Actions > Impose.
- 2 In the Fiery Impose window, click Booklet for the product intent, and Saddle for the binding type.
- 3 Click Left, Right, or Top for the binding style.
- 4 To specify sheet size, click Edit beside the Sheet text field.
- 5 To specify cover settings, click Cover, and then click None, Inside, Outside, or Both Sides in the Front Cover and Back Cover menus.

Note: You cannot change the media type for a VDP job's cover.

6 Specify Layout Orientation, and then click 2 X 2 Unique Booklet for Row & Column.

Note: 2 x 2 Unique booklet is only available for VDP jobs. If you are imposing a PostScript or PDF job, and using the same template, the setting defaults to 2 x 2 Repeat booklet.

7 Specify other settings as required.

Set bleeds or scaling in VDP imposition

Setting bleeds in VDP imposition affects trim mark location. By default, Fiery Impose places the trim marks at the edge of the image. If you apply bleed values for VDP imposition, the trim marks are offset automatically by the amount of the bleed.

- Do any of the following:
 - For Bleed, enter the bleed values in the Horizontal and Vertical fields.
 - In the Scale pane, from the Scaling menu, select Scale to Fit, 100%, or Custom.
If you chose Custom, enter a scale factor in the Scale Factor field.

Gang Up settings for VDP imposition

For VDP imposition, you can process Gang Up printing at either the page level or the record level.

Choose one of the following:

- Single Record Mode - Applies imposition to one record at the same time. Impose performs Gang Up operation to pages within a single record.
- Multiple Records Mode - Applies imposition to multiple records at a time. Impose performs Gang Up operation to pages from multiple records.

Gang Up	VDP Options VDP Gang Up	Availability	Earlier version of Fiery Impose equivalent
Unique	Single Record Mode	Enabled	Unique
	Multiple Records Mode	Enabled	Multiple Records Gang Up
Repeat	Single Record Mode	Enabled	Repeat
	Multiple Records Mode	N/A	N/A
Unique-Collate Cut	Single Record Mode	Enabled	Unique-Collate Cut
	Multiple Records Mode	Enabled	Stack and Cut
Duplo - Short Edge Feed	Single Record Mode	N/A	N/A
	Multiple Records Mode	Enabled	N/A
Duplo - Long Edge Feed	Single Record Mode	N/A	N/A
	Multiple Records Mode	Enabled	N/A

Single Record Imposition for VDP jobs

With Single Record Imposition, each record within a VDP job is imposed one record at a time. The same imposition scheme is repeated for every record.

Any imposed sheet (signature) contains pages from a single record only, and blank pages are inserted if pages from the record cannot completely fill the sheet.

Single Record Imposition for VDP jobs supports Repeat Gang Up, Unique Gang Up, and Unique-Collate Cut.

Figure 1: Example of single-record imposition using Repeat Gang Up for 8 records, 2 pages per record, 1 row x 2 columns layout, simplex. R = Record, P = Page, S = Sheet.



Figure 2: Example of single-record imposition using Unique Gang Up for 8 records, 2 pages per record, 1 row x 2 columns layout, simplex. R = Record, P = Page, S = Sheet.



Figure 3: Example of single-record imposition using Unique-Collate Cut for 8 records, 4 pages per record, 1 row x 2 columns layout, simplex. R = Record, P = Page, S = Sheet.



Multiple Records Imposition for VDP jobs

With Multiple Records Imposition, multiple records within a VDP job are imposed onto one sheet. Multiple records are processed at the same time.

Multiple Records Imposition for VDP jobs supports Multi-record Collate and Cut and Stack. Cut and Stack allows you to position multiple records on the sheets so that the cut piles can be quickly stacked without further sorting. For a large job with many records, you can divide the job into sets for easier handling.

Figure 4: Example of Multi-Record Collate for 8 records, 2 pages per record, 1 row x 2 columns layout, simplex. R = Record, P = Page, S = Sheet



Figure 5: Example of Cut and Stack for 8 records, 2 pages per record, 1 row x 2 columns layout, simplex. R = Record, P = Page, S = Sheet

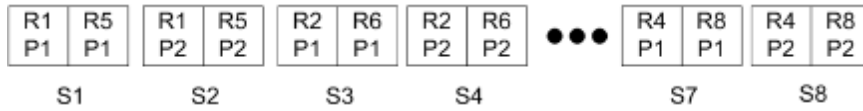

Duplo VDP Gang Up

Duplo VDP Gang Up layouts support the pagination scheme for the sheet-fed Duplo slitter/cutter/creaser finishing equipment. The Duplo gang up scheme creates pagination that lets you finish the printed sheets sequentially sheet by sheet.

Note: For Duplo Gang Up layouts, the Style setting is unavailable, and you cannot specify a Front Cover or a Back Cover.

The available Duplo Gang Up layouts are:

- Duplo - Short Edge Feed - Creates a pagination direction that lets you feed the final printed sheet into a Duplo finisher at the sheet's short edge.
- Duplo - Long Edge Feed - Creates a pagination direction that lets you feed the final printed sheet into a Duplo finisher at the sheet's long edge.

Fiery Compose

Fiery Compose, one of the Fiery make-ready applications which also include Fiery Impose and Fiery JobMaster, lets you prepare a job (spooled and held in Command WorkStation) for printing.

Fiery Compose appears in the Fiery Preview window. Fiery Impose lets you specify imposition settings in the same workflow and immediately see the results actions you take in Fiery Compose and Fiery Impose.

Note: Fiery Compose options are a subset of Fiery JobMaster, which includes more advanced job preparation options.

Fiery Compose is a dynamic application: The available options depend on which printer you select. For a single job, you can use Fiery Compose to:

- Set chapters and apply subset finishing, if supported
- Specify different media for front and back covers, body pages, and sections
- Insert blank pages, sheets, tabs, or other documents
- Edit a document using Adobe Acrobat and Enfocus PitStop

Note: The client computer must have an activated Fiery Compose license to use the full functionality of Fiery Compose.

Fiery Compose lets you work on any PDF or PostScript job at the page level. If you edit a PostScript job in Fiery Compose, Fiery Compose converts it to PDF. Any changes you make to the job appear in the Sheet View pane.

If a job contains Mixed Media settings that were set in the printer driver or Command WorkStation, these settings appear when you view the job in Fiery Compose. After you save the job in Fiery Compose, you cannot go back and make changes in the Mixed Media window.

Setting job options before using Fiery Compose

You can set finishing options, such as stapling, folding, and punching, using Command WorkStation (in Job Properties), the printer driver, or Fiery Compose.

These methods can apply changes to an entire job. However, Fiery Compose can apply finishing options to subsets within the job. We recommend that you set subset finishing in Fiery Compose.

Open and view jobs in Fiery Compose

You use the Fiery Compose window to view jobs and make changes. The Fiery Compose window has three panes: Page View, Sheet View, and Settings.

- **Page View** - Displays the selected job as single-page thumbnails.
- **Sheet View** - Displays either the entire job as thumbnails or a selected page as a full-screen preview. When you view the entire job, you can toggle between thumbnail view and wireframe view. (Displaying thumbnails as wireframes speeds up performance.) Changes immediately appear in the Page View.

You can view page thumbnails as single pages. If the job is duplex, the Sheet View displays the front and back for each sheet. You can also use Reader View to view left and right pages as in a book.

- **Settings** - Displays controls that affect the printing characteristics and layout on the final printing sheet surface. Which controls appear depend on the product intent.

Note: See [Fiery Preview](#) on page 68.

Open a job in Fiery Compose



You use Command WorkStation to open a spooled/held job in Fiery Compose.

- 1 Choose a spooled/held job in the Held list of Command WorkStation.
- 2 Click Actions > Compose.

Set the Sheet View to thumbnails or full pages in Fiery Compose

The Sheet View can switch between thumbnails and full-page view. You can also display thumbnails as wireframes.

Note: When you view a full page, the page size shown is the document bounding box, not the size of the media assigned to the page.

- Do any of the following:
 - To switch between thumbnail and full-screen views, click the Fit Page icon () at the bottom of the window.
 - To switch the thumbnail view between thumbnails and wireframe views, click the Toggle Sheet Content icon ().

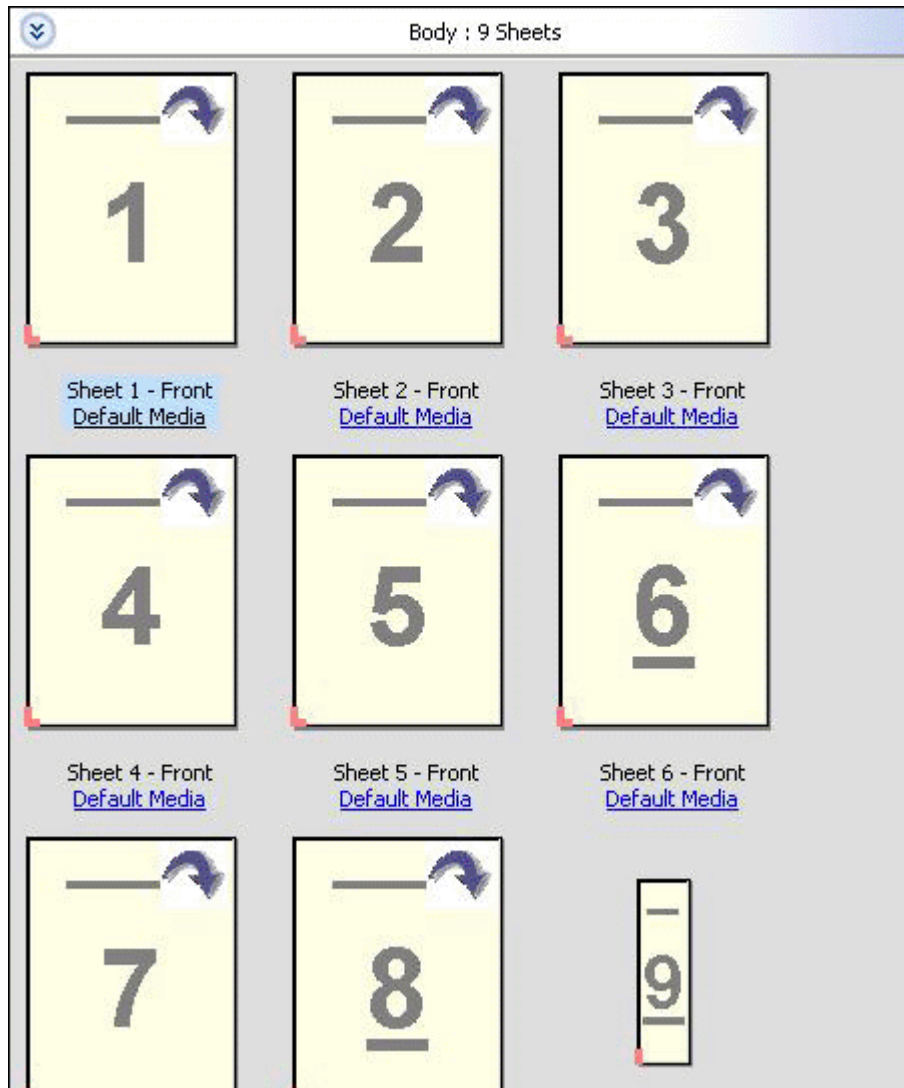

View pages as a book

Reader View opens a separate window to display left and right side pages together as if reading a book.

- Open Reader View by clicking File > Reader View.

Adjust thumbnail size

The Page View pane lets you set thumbnail size. The Sheet View pane lets you zoom or specify percentage zoom.

- Do one of the following:
 - To enlarge or reduce thumbnails in Page View, click View > Enlarge Thumbnails or View > Reduce Thumbnails.
 - To zoom thumbnails in the Sheet View, drag the slider at the bottom of the Sheet View pane.

Work with pages in Fiery Compose

Fiery Compose lets you add, rearrange, and delete pages, or insert pages from another job. You can also make pages tabs, chapter starts, or covers; assign media to pages; and set duplex for selected pages.

Important: You should edit the job before you specify any mixed media settings. Editing a job can change page numbers, which can affect mixed media settings. Always check any mixed media settings after you edit a job.

Open a job for editing in Acrobat

Fiery Compose can open a job for editing in Adobe Acrobat and Enfocus PitStop.

- Right-click a page in the Page View pane and then click Edit in Acrobat.

Reorder, delete, or set duplex for pages in Fiery Compose

You can manipulate selected pages in a Fiery Compose job.

- Do any of the following:
 - To reorder pages, click the page's thumbnail in the Page View pane and drag it to the new location.
 - To delete pages, select one or more pages and click Edit > Delete.
 - To apply duplex (if the printer supports it) to selected pages or chapters, select the pages, right-click them, click Page Duplex, and specify the setting that you want.

Note: To use duplex printing for an entire job, select the appropriate setting for the job in Command WorkStation before opening the job in Fiery Compose, or choose Duplex in the Settings pane.

Insert pages from another job in Fiery Compose

You can insert pages from a job on the Fiery Server, or from your computer.

- 1 Click Actions > Insert Page(s).
- 2 In the Insert Pages dialog box, do one of the following:
 - From a local system, click Browse, select the file, and then click Open.
 - From a Fiery Server, click Server Jobs, and click the file in the list.
- 3 Do one of the following:
 - To insert specific pages, drag them to the Page View pane and arrange them in the order you want.
 - To insert an entire job, drag the job label to the Page View pane.

Insert a blank sheet or page in Fiery Compose

Fiery Compose lets you insert blank sheets or pages anywhere in a document. Fiery Compose inserts the sheet or page before the selected page.

Note: You cannot add an insert when the selected page is a tab. If you want to add an insert before a tab, first add the insert, and then add the tab after the insert.

- 1 Select a page in the Page View pane.
- 2 Click Actions > Insert Blank Sheet or Actions > Insert Blank Page.

Assign media to pages in Fiery Compose

The Sheet View and Page View panes let you assign media to individual pages, or to ranges of pages. You can also assign media to an entire job in the Page View pane.

- 1 Select a page or pages.
- 2 Click Actions > Assign Media.
- 3 Specify the media in the Page/Page Range Media dialog box.

Work with chapter starts in Fiery Compose

To divide a document into chapters, you can mark the start of each chapter in the Page View pane, and then apply finishing options in the Settings pane. You can also remove a chapter start mark.

A chapter start page prints on the front side of a sheet. (This is the page on the right in a reader's spread.) Green checkmarks in the Page View pane indicate chapter start pages.

- Do any of the following:
 - To add a chapter start, select a page that has no chapter start mark and click Actions > Chapter Start.
 - To remove a chapter start, select a page that has a chapter start mark and click Actions > Chapter Start.
 - To show the blank pages that Fiery Compose inserts before chapter start pages, click View > Show Implicit Blanks.

Fiery Compose inserts implicit blanks if needed to accommodate chapter starts and duplex settings and to place the chapter start page on the right side in the Reader View.

Set tabs in Fiery Compose

You can add a tab page anywhere in the document and select the tab media. (All tabs in a job must use the same media, even if multiple tab media are available.)

The Convert to tab option in earlier versions of Fiery Compose has been removed. To convert an existing page in the document, or an inserted page, to a tab in Fiery Compose, right-click and select Assign Media, then select a tab media from the list, as described below.

To add an insert before a tab, add the insert first, and then add the tab after the insert. You cannot add an insert when the selected page is a tab.

You can add one tab at a time in the Preview pane. You can also set up and add multiple tabs in the Tab Text Setup window.

- 1 Select the page where you want to add a tab.

- 2 Click Actions > Insert Tab.

A tab using the default tab media is added before the selected page. (If a tab already exists in the job, new tabs must use the same media as the existing tab.)

- 3 Click the inserted tab, and then choose Actions > Assign Media.

- 4 Specify the media in the Edit Tab window.

Changing the media for one tab changes it for all tabs in the job.

Note: In Fiery JobMaster, you can add multiple media for tabs in one job. See [Add multiple tab styles to a document](#) on page 13.

Set tab text and other properties in Fiery Compose

You use the Edit Tab window to set tab text and position properties, and the tab media.

Note: Earlier versions of Fiery Compose have the Tab Text option. Edit Tab replaced this option in later versions.

- 1 Select the tab page.

- 2 Right-click the selected tab page, and then click Tab Text.

- 3 Type the desired text in the Text field.

- 4 Use menus and buttons below the Text field to specify text attributes such as font, size, alignment, and text rotation.

If the job uses portrait layout, the tab text appears vertically so you can check the text alignment.

- 5 To apply the same text settings to all tabs, click Apply the same text attributes for all tabs.

Set up covers

Fiery Compose lets you set up the front and back covers of the document independently and choose their media from the Paper Catalog. You can use the document's front and back pages as the front and back covers, or you can insert covers.

Note: You cannot add an insert or tab or mark a chapter start when the selected page is the document front or document back. See *Paper Catalog Help*, which is part of *Command WorkStation Help*.

- 1 In the Settings pane, click Cover > Define.

- 2 Do one of the following in the Cover Media dialog box:
 - To apply the same settings to the front and back cover, click **Apply the same setting for both front and back cover**.
 - To set up the front cover and back cover separately, select **Front Cover** or **Back Cover**.
- 3 Specify the settings.

Subset finishing in Fiery Compose

If the printer supports it, you can apply individual finishing options to subsets in the job, thus applying a variety of finishing options in one pass. You can define subsets according to chapters, sheet ranges, or a custom range.

First, you should specify finishing options for the whole job, including media and setting duplex if desired. For details, see [Set sheet size in Fiery Impose](#) on page 40 and [Set Duplex in Fiery Impose](#) on page 40.

You then create subsets within the job, and then specify finishing options and set media for individual subsets, ranges of sheets/pages, or individual sheets/pages.

Subset finishing rules

- Sheets in a subset must be continuous, including any inserts or tabs added in Fiery Compose.
- You use the Page View pane to define chapter starts for chapter subset finishing.
- The Settings pane specifies the sheet count for sheet subset finishing. Each subset contains the same number of sheets.
- The Sheet View pane defines custom subsets. Each subset can be of any length.
- If you switch the Set Definition from chapter or "number of sheets" to custom, the previously defined subsets are the starting point for the Custom settings.
- Switching the Set Definition from custom to chapter or number of sheets removes the custom subsets and replaces them with the new definition.
- All sheets within a subset must be of the same size, except for tabs and Z-fold inserts.
- You cannot specify covers for finishing subsets.
- If you define subsets for a single-sided or simplex job, and then specify duplex for the job, note that:
 - For sheet subset finishing, the subsets maintain the sheet count. For example, a subset that was 3 pages on 3 sheets remains as 3 sheets, but with 6 pages.
 - For chapter and custom subset finishing, the subsets maintain the page count, adding blanks as necessary to fulfil the duplex requirement.

Specify a set definition in Fiery Compose

You specify subset finishing by specifying the Set Definition in the Settings pane, and then applying finishing options.

- 1 In the Settings pane, click one of the following in the Set Definition menu:
 - Custom - Defines subsets by selecting different ranges of sheets as desired in the Sheet View pane.
 - Chapters - Specifies chapter starts to create subsets.
 - Number of sheets - Specifies a fixed number of sheets to a subset, so that each subset consists of the same number of sheets.
- 2 Click OK.

Apply subset finishing in Fiery Compose

You can apply chapter, sheet, or custom subset finishing.

To apply chapter subset finishing, specify chapter starts and then set finishing and media for the chapter subsets. The Sheet View pane displays the job divided into the chapter subsets.

To apply sheet subset finishing, specify how many sheets are in a subset. Fiery Compose then divides the job into subsets of equal length.

Custom subset finishing provides full control of the length of subsets. You specify subsets in the Sheet View pane. Each custom subset can contain a different number of sheets.

- 1 In the Settings Pane, click options in Fold, Hole-Punch , and Stapling menus.
- 2 If you are applying chapter subset finishing, do the following:
 - a) Select a chapter start page in the Page View pane and click Actions > Chapter Start.
 - b) In the Settings pane, click Chapters in the Set Definition menu.
- 3 Assign global media, if desired.
- 4 If you want subsets of equal length (sheet subsets), select Number of Sheets from the Set Definition menu in the Settings pane. Then type the number of sheets you want in a subset.
- 5 If you are applying custom subset finishing, do the following:
 - a) In the Settings pane, click Custom in the Set Definition menu.
 - b) In the Sheet View pane, select the beginning sheet of a subset, right-click, and click Create Subset. Repeat for each subset.
- 6 Remove unwanted finishing options from individual subsets.
- 7 To assign media, do one of the following:
 - To assign media to individual subsets, right-click the subset header and select Assign Media.
 - To assign media to individual sheets or a range of sheets within a subset, select the sheets, right-click, and select Assign Media.
- 8 To perform other functions on the subset, right-click the header bar and choose from the menu.

- 9 To remove a subset, select it, right-click, and then select Remove Subset.

Specify subset finishing for Z-fold in Fiery Compose

If your printer supports Z-fold finishing, you can specify Z-fold for individual sheets in a subset.

The Z-fold insert is twice the size of the subset body paper, and both must be standard sizes that the printer and the folding finisher support. (Custom sizes are unsupported.) The feed edge of both the body paper and the Z-fold insert must be the same size.

For example, if you have a Letter size job, the Z-fold insert will be 11 x 17, short-edge feed. If your job is A4, the Z-fold insert will be A3, short edge feed.

- 1 In the Settings pane, click Z-fold in the Fold menu.
- 2 In the Sheet View pane, select a sheet, right-click and then click Z-fold.

Manage jobs in Fiery Compose

Fiery Compose provides tools for saving, deleting, and printing a job.

Save a job in Fiery Compose

If you make changes to a job in Fiery Compose, you must save it before you print it.

- 1 Click File > Save.
- 2 Choose one of the following options:
 - Save as a regular job - Saves to the Fiery Server.
 - Save as PDF file - Saves to a local disk.

Delete a job that is open in Fiery Compose

To delete a job that is open in Fiery Compose, return to the Command WorkStation interface.

- 1 Close the job in Fiery Compose.
- 2 Delete the job from Command WorkStation.

For more information, see *Command WorkStation Help*.

Fiery Preview

You can view the page and sheet content of a job in Fiery Preview and specify print options. You can perform additional make-ready tasks in preparation for printing jobs, including imposition.

Fiery Preview is a pre-raster image process (pre-RIP) preview and displays jobs that have been spooled, but not processed. If you have Fiery Impose and Fiery Compose or Fiery JobMaster enabled, you can integrate the functions of the combined workflows in the Preview window, and view the results of your actions before printing.

- Fiery Impose converts jobs to PDF file format and allows you to create imposition layouts.
- Fiery Compose allows you to set chapters, add blank pages, and specify different media for a job.
- Fiery JobMaster offers access to complex document preparation tasks such as tab insertion, scanning, chapterization, page numbering, and late stage editing. JobMaster includes Fiery Compose options.

Note: For information on Fiery Impose/Compose/JobMaster, see JobMaster Help.

Note: You can create a brand new print job in the Fiery Impose/Compose/JobMaster window by selecting the New Job icon in the Command WorkStation tool bar. Create a new job when you want to prepare a job from a scanned document, print a tabs-only job, or combine existing jobs, starting from an empty job.

Reader Preview is accessed from the main Fiery Preview window and displays jobs as they will look after they are printed.

If you select Preview for a processed job, the job opens in raster preview mode. Printed and archived jobs with raster data can be previewed. Archived jobs with raster data must be archived on the Fiery Server.

If you have Fiery Graphic Arts Package, Premium Edition, installed, you can view the raster image of a processed job in ImageViewer and adjust colors and perform other soft-proofing actions. ImageViewer is accessed from a button in the raster preview window.

To open a rasterized job and specify settings in Fiery Impose/JobMaster/Compose, select the job in Command WorkStation Job Center and select Remove Raster from the Actions menu.

View information for processed jobs

The Job Summary pane lists specific information for the a selected job that has been processed and displays thumbnails for all pages in that job. The selected job file name is shown at the top of the pane, along with thumbnails for all pages of the job, only if processed and held.

If a job is processed, you can view it in the Job Summary pane in Job Center. The Raster Preview window for a processed job does not open Fiery Compose, Fiery JobMaster, or Fiery Impose. You can open ImageViewer if the Fiery Graphic Arts Package, Premium Edition or the Fiery Productivity Package is supported on the Fiery Server.

Start Command WorkStation and select a processed job in the held list to display it in the Job Summary pane.

The Job Summary pane is at the right of the Command WorkStation window.

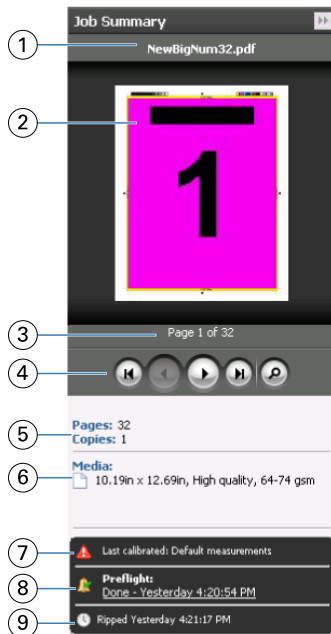

1	Job name
2	Thumbnail of processed job
3	Number of page displayed
4	Navigation tools. The magnifying glass opens the job in the raster preview window.
5	Total number of pages in the job or number of VDP records (only for VDP jobs) and number of copies
6	Media information, such as page size, orientation, media type or media weight
7	Job instructions/notes to the operator
8	Run Preflight on the job or view the Preflight report
9	Last action taken on the job, such as spooled, processed, or printed, along with a date and time stamp

View spooled, unprocessed jobs

To view spooled jobs, you use the Preview window.

- 1 In Job Center, select a spooled job in the Held queue.

Note: If the job is processed, you see the job in raster preview and have access to limited functions.

- 2 Choose one of the following ways to open the Preview window:

- Right-click and select Preview.
- In the Actions menu, select Preview.
- Click the Preview icon in the Command WorkStation toolbar.

- In the Job Summary pane, click the Launch Preview icon (the magnifying glass icon below the thumbnail).
- Click the New job icon in the Command WorkStation tool bar.

Note: Choosing New job creates a blank job in the Fiery Impose/Compose/JobMaster workspace. You can then apply Fiery Impose/Fiery Compose/Fiery JobMaster settings to the job.

The following illustration shows the standard Preview window. If the Page View and Settings panes are hidden when you first open Preview, click the arrows at the left and right of the toolbar respectively.

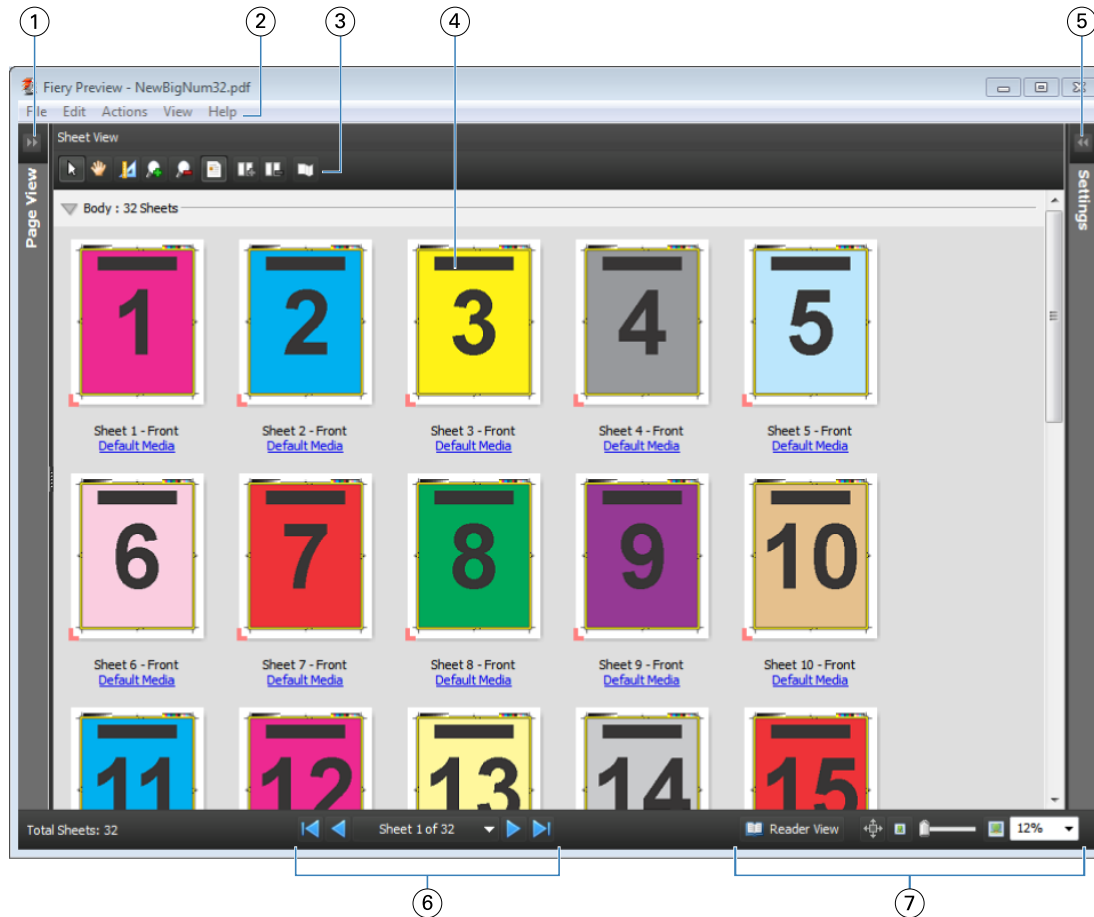

1	Toggle arrows to access page view	See Page View, Sheet View, and Reader View on page 71
2	Menus	See Fiery JobMaster on page 8
3	Toolbar icons	See Toolbar icons in Preview on page 74
4	Thumbnails in sheet view	See Open and view jobs in Fiery Compose on page 60
5	Arrows to access settings pane	See Settings pane on page 72
6	Navigation tools	See Open and view jobs in Fiery Compose on page 60
7	Zoom controls	See Fiery JobMaster on page 8

Page View, Sheet View, and Reader View

The Page View displays the thumbnail preview of the working document - the input.

If you have Fiery Compose or Fiery JobMaster enabled, in Page View, you can accomplish the following tasks:

- Insert page(s) from other documents
- Insert blank pages
- Add tabs
- Insert other jobs
- Merge jobs
- Delete pages
- Reorder page(s)
- Replace page(s)
- Edit content

For more information, see [JobMaster Help](#) and [Fiery Compose](#) on page 59.

The Sheet View shows the imposition (layout of the content on the sheets as they will be printed on the printer) of the job. It is a pre-RIP preview of the actual sheet.

The Reader View opens a secondary window to display the document as it will look to the reader when printed, after it has been folded, cut, and bound.

The illustration below shows thumbnails displayed in the Page View and the Sheet View panes. Any actions you perform in the Page View pane are immediately displayed in the Sheet View.



- | | | |
|---|--------------------------|---|
| 1 | Page View pane | See Open and view jobs in Fiery Compose on page 60 |
| 2 | Page View toolbar icons | See Toolbar icons in Preview on page 74 |
| 3 | Thumbnails in Page View | See Open and view jobs in Fiery Compose on page 60 |
| 4 | Sheet View toolbar icons | See Toolbar icons in Preview on page 74 |
| 5 | Sheet View pane | See Open and view jobs in Fiery Compose on page 60. |
| 6 | Thumbnails in Sheet View | See Open and view jobs in Fiery Compose on page 60 |

Settings pane

In the Settings pane of the Preview window, you can specify imposition settings, and the changes you make are displayed in the Sheet View pane.

Imposition settings are performed with Fiery Impose software. If you have not activated a Fiery Impose license, you can still impose a spooled job in the Preview window and use Fiery Impose in Demo mode. You will be able to save the job as a .dbp file to the Fiery Server, but not as Adobe PDF. You can print the job with a watermark.

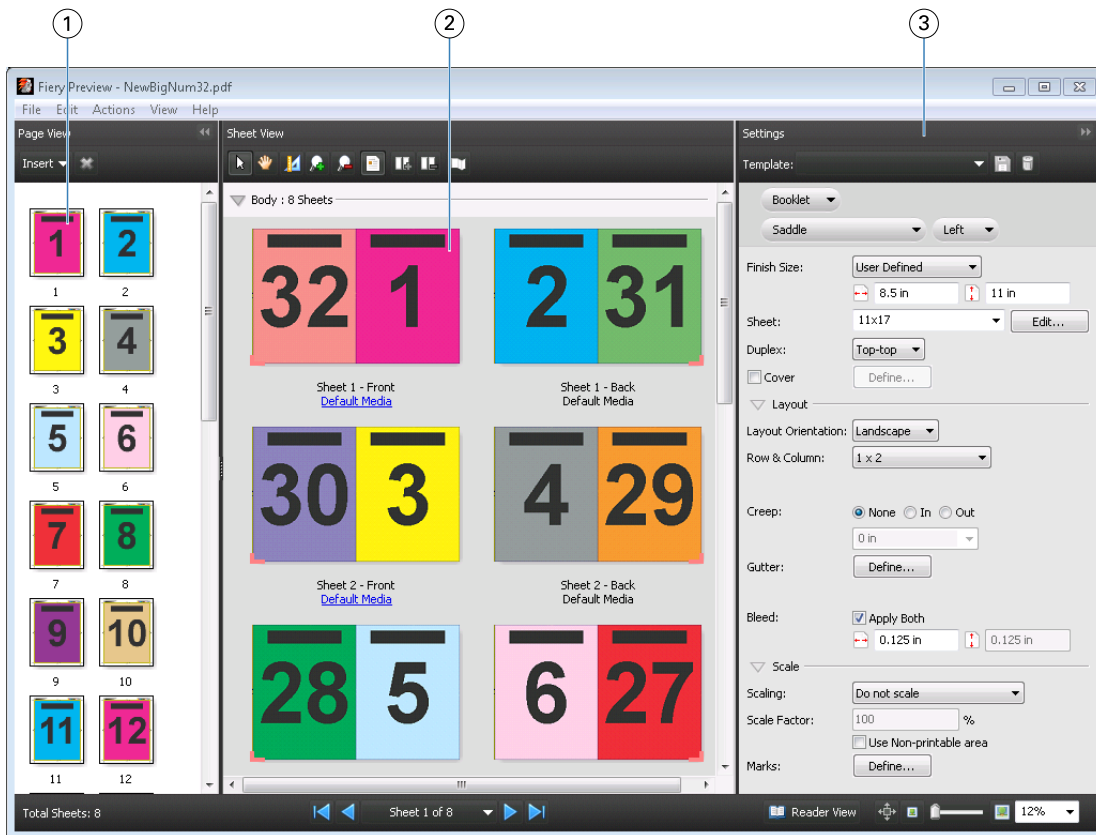

Note: If the Settings Pane is not displayed in the Preview window, click the arrows in the Preview window toolbar. To view imposition settings, select Booklet or Gangup from the menu at the top of the Settings pane.



- 1 *Thumbnails in Page View pane* See [Open and view jobs in Fiery Compose on page 60](#)
- 2 *Thumbnails in Sheet View pane* See [Open and view jobs in Fiery Compose on page 60](#)
- 3 *Settings pane* See [Fiery Impose on page 17](#)

Open Reader View

The Reader View displays a “reader’s spread,” which shows pages in the order and layout in which they are meant to be read.

- 1 Right-click an unprocessed job in the Held list in Command WorkStation and select Preview.
You can select Fiery Impose, Fiery Compose, or Fiery JobMaster if any of the applications are activated.
- 2 Apply settings to the job in the Fiery Preview window and save.
- 3 Click the Reader View icon  in the bottom toolbar.
 - Use the arrows at the bottom of the window to navigate through the document. Zoom controls are at the right.
 - The pan icon  allows you to move the image around the window.
 - Click Media Info to display information about the document.
 - Rotate the document by holding down the Alt key and the left mouse. Rolling the mouse wheel allows you to zoom the image.

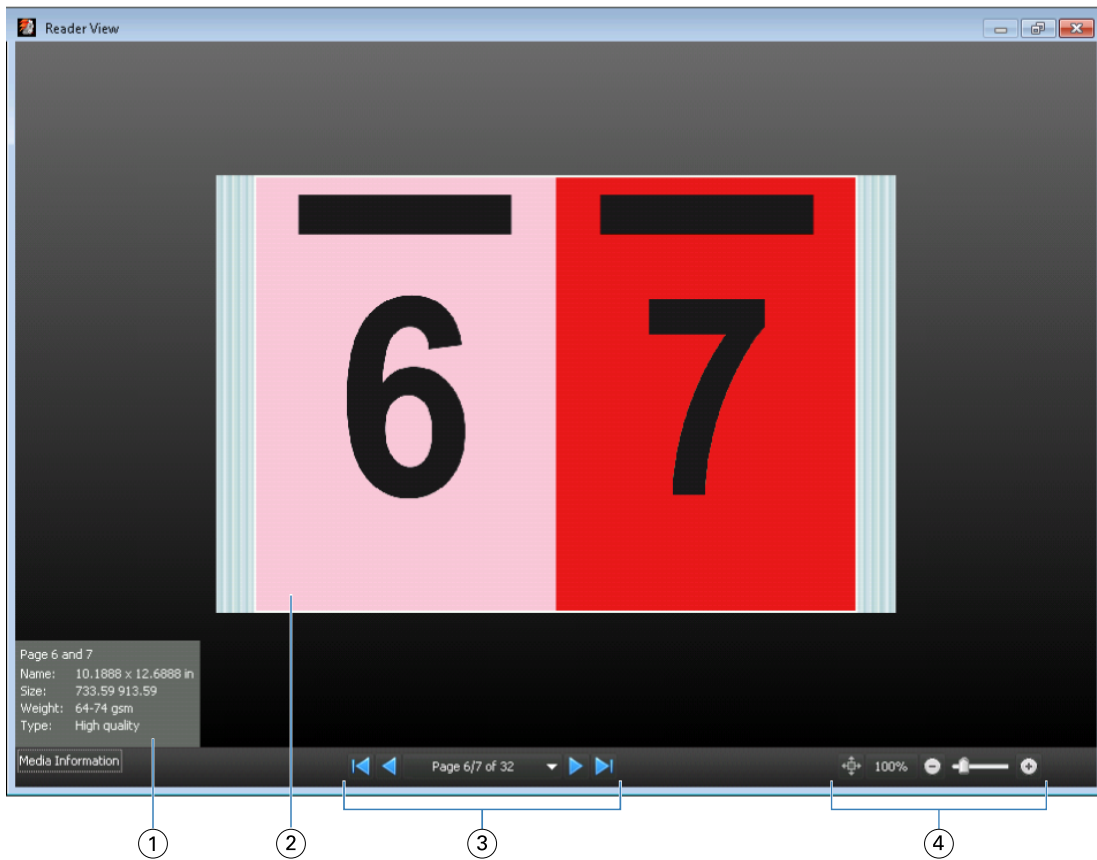

1	Media information about the pages displayed
2	Pages from the document displayed
3	Navigation controls
4	Zoom controls

Toolbar icons in Preview

The icons shown below are on the standard Preview toolbar. If you have Fiery Compose or Fiery JobMaster enabled, you have access to more tools.

 Select a sheet or page in the Preview window.

 Drag the preview around in the window.

 Show measurement of page elements.

 Zoom in.

 Zoom out.

 Show sheet content toggles between thumbnail view and the wireframe view. The wireframe view shows the pagination of records.

Preview a raster image

If a job is processed, you can view it in the Job Summary pane in Job Center, or in the Raster Preview window, you see the raster image that will be produced on the paper output. A job must be processed. Minimal functionality is supported.

If a job is processed, you can view it in the Job Summary pane in Job Center. The Raster Preview window for a processed job does not open Fiery Compose, Fiery JobMaster, or Fiery Impose. You can open ImageViewer if the Fiery Graphic Arts Package, Premium Edition or the Fiery Productivity Package is supported on the Fiery Server

To open Raster Preview, do one of the following:

- Click Preview in the Actions menu.
- Click Preview button in the toolbar.
- Right-click (Windows) or Control-click (Mac OS) selected job in the Held list and select Preview.

The following illustration shows the raster preview of a job.





1	Toolbar icons for saving, duplicating, or deleting the job
2	Thumbnails in the Page View pane
3	Raster file in the Raster View pane
4	Navigation tools for paging through the job and displaying the sheet number

Toolbar icons in Raster Preview

The icons shown below are on the standard Raster Preview toolbar. If you have Compose enabled, you have access to more tools.

 Save the currently displayed file under a new name.

 Duplicate the selected page(s).

 Delete the selected page(s).

 Launch ImageViewer opens the ImageViewer window if the Fiery Server supports either the Fiery Graphic Arts package or the Fiery Productivity Package.

Merging pages in Raster Preview

You can open multiple Preview windows with different jobs, but all jobs must come from the same Fiery Server. You can edit the jobs in each window separately. You can also drag pages from one window to another.

When you drag a page from one window to another, the source window (from which you dragged the job) becomes Read Only. The destination window is editable, but you must save the new job with merged pages in the destination window before the source window becomes editable again.

VDP Raster Preview

You can preview a processed Variable Data Printing (VDP) job in the Raster Preview window. Previews include any imposition settings that may have been applied to the job. The content of the job is displayed actual size, organized by records or finished sets.

In the VDP Raster Preview, you can do the following:

- Navigate through the job by records or finished sets and pages or surfaces. The navigation parameters displayed change dynamically, depending on whether the job is imposed or not.
- Change the size of the thumbnails in the Page View.
- Expand or collapse records or thumbnails.
- Open the job in the ImageViewer window.

Note: The Save, Duplicate, and Delete functions are not available for VDP jobs displayed in the Raster Preview window.

Preview of a VDP job before imposition

When a processed VDP job is displayed before imposition in the Raster Preview window, you can navigate by records and pages. You can also open the job in the ImageViewer window, if it is supported by the Fiery Server.

Note: The Save, Duplicate, and Delete functions are not available for VDP jobs displayed in the Raster Preview window.

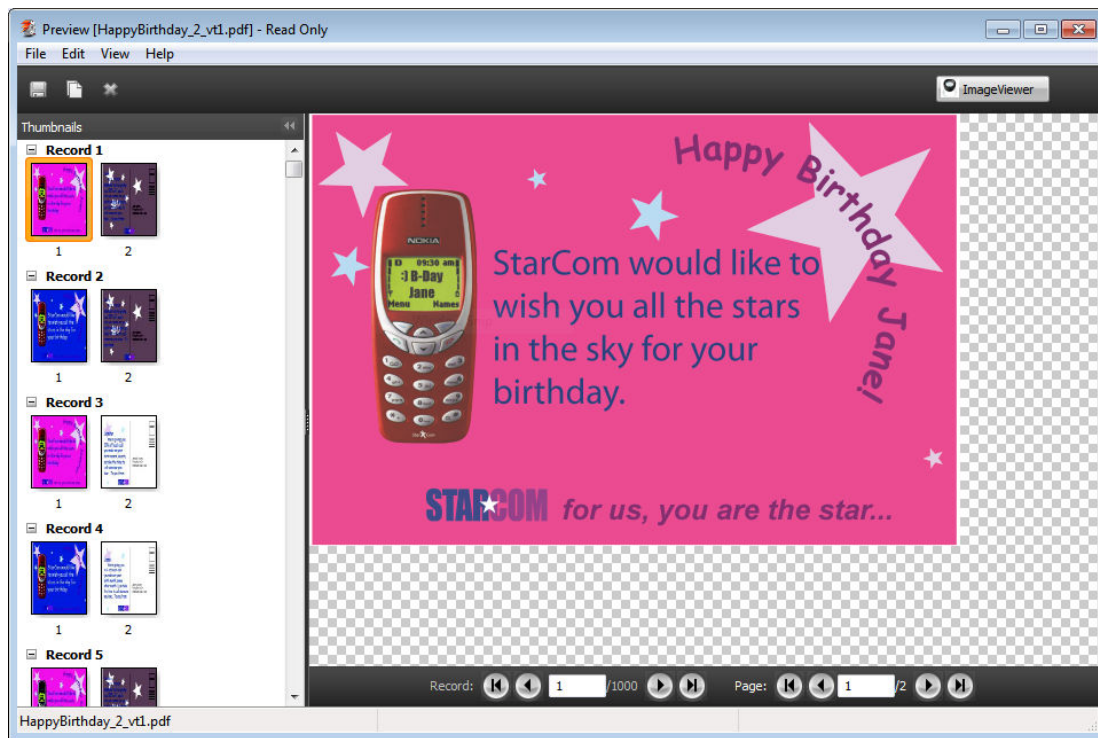

Preview of a VDP job after imposition

When a processed VDP job is displayed after imposition in the Raster Preview window, you can navigate by finished sets and surfaces.

If you want to impose a processed VDP job, you must remove the raster data, impose the job, save it in .dbp format, process it, and then open it in the Raster Preview window. You can also open the job in the ImageViewer window, if it is supported by the Fiery Server.

Note: The Save, Duplicate, and Delete functions are not available for VDP jobs displayed in the Raster Preview window.

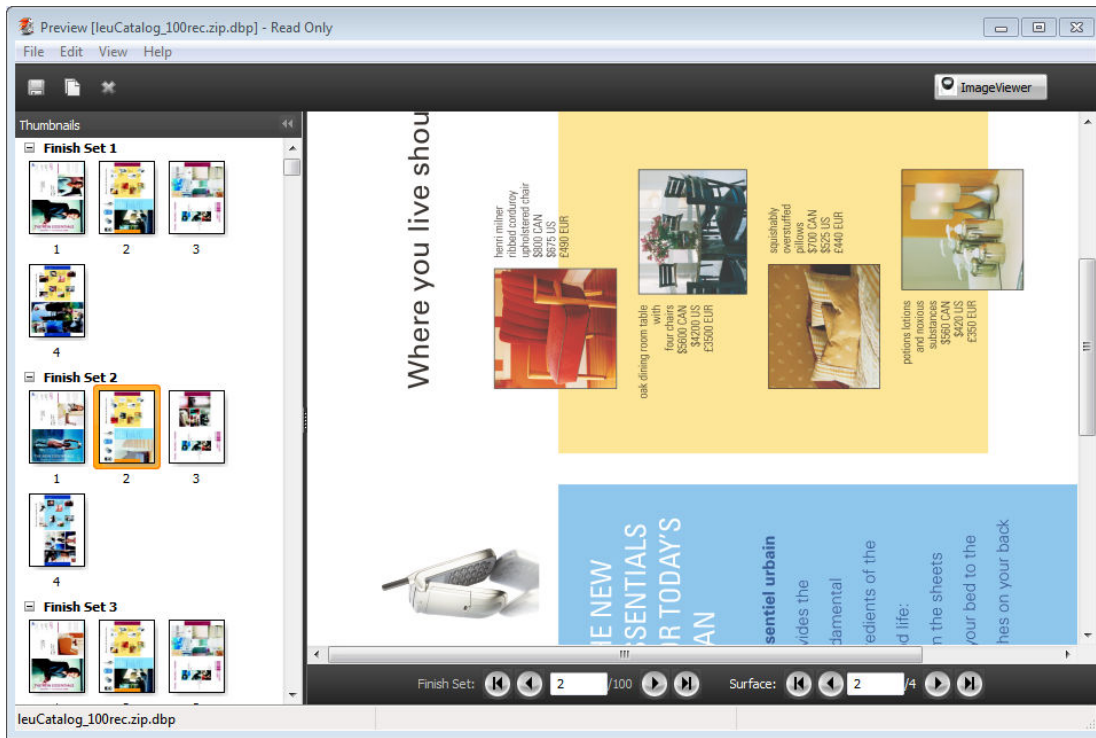

Display of gangup VDP jobs

If a VDP job is imposed as Gangup (either Cut & Stack or Deploy) and the Stack Size is set to All, the job consists of one finished set. In this workflow, you can navigate by surface only. If the Stack Size is set to more than one, you can navigate by finished set and surface, as with any other imposed VDP job.

Index

A

- About
 - sheets 19
 - signatures 19

B

- binding
 - specifying 46
- bleeds
 - setting for standard job 41
 - setting for VDP 56

C

- 17
- Compose, about 7
- Cut and Stack 57

D

- duplex 19

F

- Fiery JobMaster 7

G

- Gang Up
 - for VDP 56
 - styles 49, 50
- gutters
 - setting for standard job 19

I

- ImageViewer
 - previewing a job with 68
- Impose, about 7
- imposed job
 - saving 28
- imposing jobs 7
- imposition
 - Gang Up 20
 - Gang Up Repeat 20
 - Gang Up Unique 20
 - templates 28
 - Unique-Collate Cut 20
- imposition layouts 7
- Imposition Template Path preference 24

J

- JobMaster, about 7

jobs

- VDP 7
- job template, applying 27

M

- margin size 19
- measurement units 24
- measuring distances 25
- Mixed Media settings 59
- Multiple Records, imposing 57
- Multi-Record Collate 57

O

- opening a job in Impose 18
- overwriting source file 28

P

- pages
 - inserting blank 53
- page view 61
- Preferences
 - Imposition Template Path 24
- previewing
 - scrolling pages 68
 - with ImageViewer 68
- Printer's Marks
 - adding 42

R

- Repeat Gang up, Single Record 57

S

- sheet dimensions, displaying 25
- sheets
 - deleting 53
- simplex 19
- single records, imposing 57

T

- tab properties 64
- tab text 64
- template
 - creating 26

U

- Unique
 - Single Records 57
- Unique-Collate Cut

Single Records 57

V

Variable Data Printing

 Cut and Stack 21

 Multi-Record Collate 21

 Stack Size 21

VDP jobs

 imposing 7